

Thank you for choosing

Panasonic Omnivision **VHS**

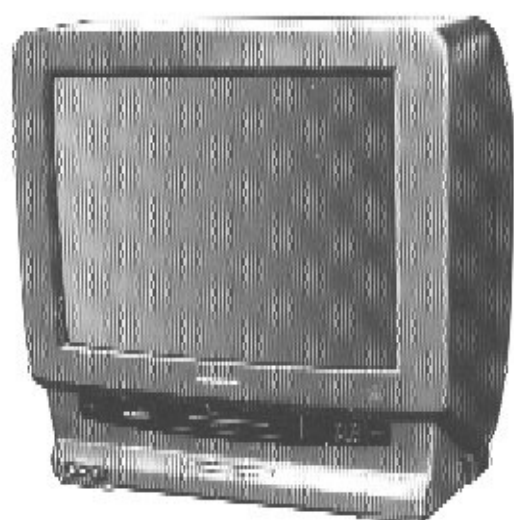

Combination VCR

MODEL PV-M2066

VCR *plus*

Operating Instructions

Before attempting to connect, operate or adjust this product and save this manual, please read these instructions completely.

Spanish Quick Use Guide is included.

Guía para rápida consulta en español está incluido.

P2 ~ P8
Getting Started

P9 ~ P13
Basic TV Operation

P14 ~ P16
Basic VCR Operation

P17 ~ P27
More You Can Do

P28 ~ 35
Other Information

Things You Should Know

Congratulations

on your purchase of one of the most sophisticated and reliable products on the market today. Used properly, we're sure it will bring you and your family years of enjoyment. Please take time to fill in the information at right. The serial number is on the tag located on the back of your Combination VCR. You'll want to keep this manual handy as your convenient Combination VCR information source.

Date of Purchase _____
Dealer Purchased From _____
Dealer Address _____
Dealer Phone No. _____
Model No. **PV-M2066** _____
Serial No. _____

Safety Precautions

Warning: To prevent fire or shock hazard, do not expose this equipment to rain or moisture. This video recorder, equipped with the HQ (High Quality) System, is compatible with existing VHS equipment. Only use those tapes with the **VHS** mark. It is recommended that only cassette tapes that have been tested and inspected for use in 2, 4, 6, and 8 hour VCR machines be used.

This television receiver provides display of television closed captioning in accordance with §15.119 of the FCC rules.

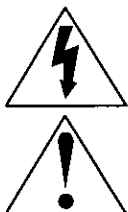
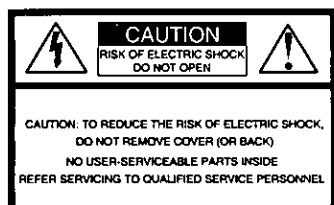

This symbol warns the user that uninsulated voltage within the unit may have sufficient magnitude to cause electric shock. Therefore, it is dangerous to make any kind of contact with any inside part of this unit.

This symbol alerts the user that important literature concerning the operation and maintenance of this unit has been included. Therefore, it should be read carefully in order to avoid any problems.

Table of Contents

Important Safeguards and Precautions	3
Unpacking Your Combination VCR and Features	4
Getting Started	
Basic and Cable Connections (Outdoor Antenna, Cable Box, Scrambled/Unscrambled Channels)	5
One Time Setup (On-Screen Language, Channel Memory, Auto Clock Set)	6, 7
On Screen Displays (OSD) (Function, Channel, Menu, VCR Status/Clock, Warning, Instruction)	8
Basic TV Operation	
TV Operation (Main Operation, Using the 100 key, Rapid Tune, Audio Mute, Phones)	9
Audio Adjustment (Bass, Treble, Reset)	10
Picture Adjustment (Color, Tint, Bright, Picture, Sharpness, Reset)	11
TV Timer Features (On Timer, Sleep Timer)	12
Closed Caption System (Main Operation, Caption On Mute)	13
Basic VCR Operation	
Playback a Tape (Special Effects, Quality Picture Features)	14
Tape Operation (Repeat Play, One Minute Skip, Zero Search, Auto Functions)	15
Record On a Tape (Main Operation, One Touch Record, Input Select)	16
More You Can Do	
Copying Your Tapes (Connection, Main Operation)	17
Timer Recording (Main Operation, Cancel-Clear-Replace Program)	18, 19
Timer Recording Using Unit Buttons	19
Special VCR Features (VCR Lock, Warning Beeper, Speaker On/Off System)	20, 21
MTS Broadcast/VHS Hi-Fi Stereo System (Stereo/SAP/Mono Broadcast, Select Audio Mode)	22, 23
VCR Plus+ Setup	24, 25
VCR Plus+ Programing	26
Cable Box Universal Remote Control Operation (Main Operation, Cable Box Code List)	27
Other Information	
Unit and Cassette Information	28
Before Requesting Service (Self-check Items)	29
Index of Controls	30, 31
Spanish Quick Use Guide/Guía para rápida consulta	32, 33, 34, 35

Important Safeguards and Precautions

INTRODUCTION

Careful attention has been given to this Video product to assure a quality standard devoted to your safety and enjoyment. This quality standard together with your personal responsibility for the safety of yourself and others, will contribute to your enjoyment. This Video product uses electrical energy and requires proper handling at all times.

CAUTION

READ AND RETAIN THE SAFETY AND OPERATING INSTRUCTIONS To make full use of the safeguards incorporated in this unit, read and follow this basic guide, adopted in part from Underwriter's Laboratories Standard 1409, Second Edition, before operating this Video product.

FOLLOW THE INSTRUCTIONS AND BE SURE TO HEED ALL WARNINGS on unit and in the manual, for easy maintenance, proper and trouble free operation of this Video product.

INSTALLATION

- OPERATE FROM A POWER SOURCE INDICATED** on this Video product, or in this Manual. Your Electric Utility Service Company or Video Products Dealer will be happy to verify the power source in your home.
- THE GROUNDED OR POLARIZED PLUG IS A SAFETY FEATURE** This Video product may be equipped with either a polarized 2-wire AC line plug or a 3-wire grounding type plug. The two wire polarized plug (having one blade wider than the other) will fit into the power outlet only one way. If it is a three wire grounding type plug (having a third pin), it will fit into a grounding type outlet.
DO NOT DEFEAT THE SAFETY PURPOSE OF THE GROUNDED OR POLARIZED PLUG by tampering with it. If the plug does not fit fully into the socket, try reversing it. If you should still be unable to fully insert the plug into the socket, you may find that a proper outlet is needed to meet today's Electrical Standards. An electrician will replace your outlet safely.
- POWER SUPPLY CORDS SHOULD BE PROTECTED** and routed so that they are not likely to have anything rest on them, roll over them, or be subject to walking traffic or abuse: particularly at plug-ins, convenience receptacles, or cord exit points from the unit. Where an extension is needed, use a grounded or polarized cord.
HAZARDOUS FRAYED CORDS OR DAMAGED PLUGS SHOULD BE REPLACED BY A QUALIFIED SERVICE TECHNICIAN.
OVERLOADED WALL OUTLETS AND EXTENSION CORDS PRESENT DANGEROUS RISKS OF FIRE OR ELECTRICAL SHOCK.
- AVOID BLOCKING VENTILATION HOLES**
Your video unit has ventilation openings in its cabinet to release heat generated during operation. Blocking these openings can cause heat build-up inside the unit, causing failure that may result in a fire hazard or heat damage to cassettes. For protection:
 - Never cover the bottom ventilation slots or the unit with soft material, or operate the unit placed on a bed, sofa, rug, or soft accessory.
 - Avoid built-in installations, such as a bookcase or rack, unless proper ventilation is provided.
- AVOID EXTREMELY HOT LOCATIONS OR SUDDEN CHANGES IN TEMPERATURE** such as placing the unit near or over a radiator, in direct sunlight, closed vehicles, or transporting it suddenly between areas of extreme temperature variation.
If the unit is suddenly moved from a cold place to a warm place, moisture may form on the tape and inside the unit.
- TO AVOID INJURY TO A CHILD, ADULT; OR COSTLY DAMAGE:**
 - Do not place unsecured equipment on a sloping surface or any heavy object or unit.
(Use the unit in a horizontal position and do not place anything heavy on it.)
 - Support for the unit should be adequately firm, level, and strong. Replace any unstable cart, table or support. An appliance and cart combination should be moved with care. Quick stops, excessive force, and uneven surfaces may cause the appliance and cart combination to overturn.
 - Carefully follow all operating instructions and use the manufacturer's recommended accessories when operating this unit or connecting it to any other equipment.



OUTSIDE ANTENNA, EQUIPMENT, AND POWERLINE EXPOSURE

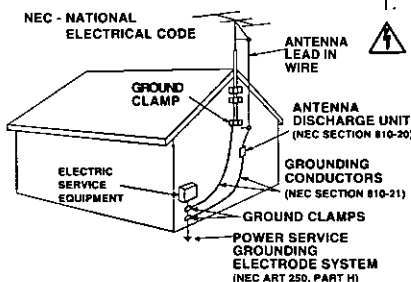

- INSURE SAFE ANTENNA AND CABLE CONNECTIONS** If an outside antenna or cable system is connected to the equipment, be sure the antenna or cable system is grounded so as to provide some protection against built up static charges and voltage surges. Part 1 of the Canadian Electrical Code, in USA Section 810 of the National Electrical Code, ANSI/NFPA 70, provides information with respect to proper grounding of the mast and supporting structure, grounding of the lead-in wire to an antenna discharge unit, size of grounding conductors, location of antenna discharge unit, connection to grounding electrodes and requirements for the grounding electrode.
- ELIMINATE ANTENNA PROXIMITY TO HIGH VOLTAGE POWER SOURCES, OR CHANCE OF ACCIDENTAL CONTACT BY INSTALLER** An outside antenna system should be located where it will never be reached by power lines, electric light or power circuits and where it will never contact these power sources if it falls. Installer should use extreme care to avoid possible fatal contact by touching power lines, circuits or other power sources when installing an outside antenna.

USE

AFTER STORING OR WHEN MOVING THE UNIT, REFER TO THE INSTALLATION SECTION OF THE SAFEGUARDS.

- DO NOT USE THIS VIDEO UNIT NEAR WATER:** around bathtubs, sinks, laundry, wet basement, swimming pool or any water source.
- USE ACCESSORIES RECOMMENDED ONLY BY THE MANUFACTURER** to avoid risk of fire, shock or other hazards.
- UNPLUG ALL EQUIPMENT EXPOSED TO RAIN, MOISTURE, OR STRONG IMPACT AND GET A QUALIFIED INSPECTION** If your unit has been exposed to rain, water, excessive moisture, or subjected to strong impact, unplug it and have it inspected by a service technician before use.
- UNPLUG UNUSED UNIT, AND ALL EQUIPMENT DURING A STORM** During a lightning storm, when indoors or outdoors, or before leaving unit unused for extended periods of time, disconnect all equipment from power source, antenna and cable system.
- UNPLUG ALL EQUIPMENT BEFORE CLEANING.** After unit has been unplugged use a dry, clean, chemically untreated cloth. Use no cleaning fluids, aerosols, or forced air that could over-spray, or soak into the unit, and cause electrical shock. Any substance such as wax, adhesive tape, etc. may affect the cabinet surface. Exposure to greasy, humid, or dusty areas may affect internal parts.
- WHEN PLUGGED-IN: KEEP WATER AWAY; NO FINGERS INSIDE NOR ANY OBJECTS INSIDE; AND NO MAGNETS OR ELECTRICAL INTERFERENCE NEARBY.**
 - Never operate the unit if liquid has been spilled into it. Immediately unplug the unit, and have it inspected by a service technician. Fire and shock hazards can result from electrical shorts caused by liquid contact inside.
 - Caution the children about dropping or pushing objects into the unit. Some parts inside carry hazardous voltages and contact can cause electric shock. Objects dropped in electrical equipment can cause fire hazards.
 - Separate the unit from any interference causing appliances. Placing the unit directly above or below your TV set may cause electrical interference. Keep all magnets away from electronic equipment.

SERVICE

- DO NOT ATTEMPT TO SERVICE THIS PRODUCT YOURSELF.** If this Video product does not operate as described, when the detailed Operating Instructions are followed, do not attempt to open or remove covers, or make any adjustments not described in the manual. Attempting to service this unit yourself may expose you to dangerous voltage or other hazards. Refer all servicing to qualified service personnel.
- CHECK ON REPLACEMENT PARTS REQUIRED.** Be sure the service technician has used replacement parts specified by the manufacturer or having the same characteristics as the original part. Unauthorized substitutes may result in fire, electric shock or other hazards.
- HAVE TECHNICIAN PERFORM SAFETY CHECK** described in the manufacture's service literature, after any service or repairs, to determine that the Video unit is in safe operating order.

Unpacking Your Combination VCR and Features

Unpacking Your Combination VCR

The accessories shown below are provided to help you use or set up your Combination VCR. Optional accessories are also listed.

Accessories

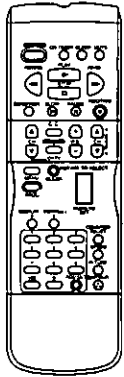

Remote Control
VSQS1444

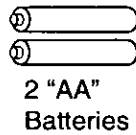

2 "AA"
Batteries

Optional Accessories

- 1/2" Video Cassette Tape

Load the batteries in the Remote Control

- 1** Lift off the lid after pressing in and up on the latch with your thumb nail or other narrow object.

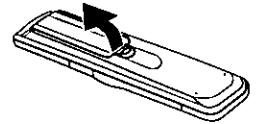

- 2** Install two batteries as indicated inside the Battery Compartment.

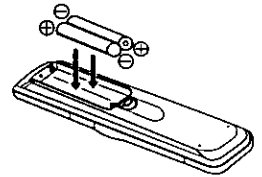

- 3** Fit the lid's hinge piece into the indent on the case, and snap lid into place.

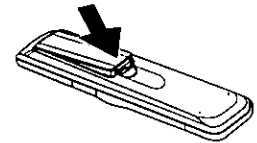

Battery replacement caution

- Do not mix old and new batteries. (Also, never mix alkaline with manganese batteries.)

Product Features

All Channel Auto Set/181-CH TV/CATV Tuner	6
Auto Clock Set.....	6, 7
Auto Daylight Saving Time	28
Auto Operation Functions (Auto Playback, Rewind, Tape Eject, Power Off)	15
Auto Repeat Function.....	15
Cable Box Universal Remote Control Feature	27
Closed Caption System	13
Easy-to-Read On Screen Displays	6, 7, 18, 19
Front-mounted A/V In Terminals	17
MTS Broadcast System.....	22
One Minute Skip.....	15
One Month, 8 Program Auto Timer Recording	18, 19
One Touch Recording (OTR)	16
PanaBlack™ Picture Tube	14
Program Director Remote Control	18, 19
Quick Play Mechanism	29
Rapid Tune.....	9
Special Effects Playback	14
Special VCR Features (VCR Lock, Warning Beeper)	20
VCR Plus+ Recording	26
VHS Hi-Fi Stereo System	23
Zero Search.....	15



Basic and Cable Connections

Outdoor Antenna Connection

Unhook the antenna from your previous TV or VCR and connect it to the back of the Combination VCR as shown in the diagram. If your antenna system has separate UHF and VHF lead-ins, you need a UHF/VHF Band Mixer (not supplied).

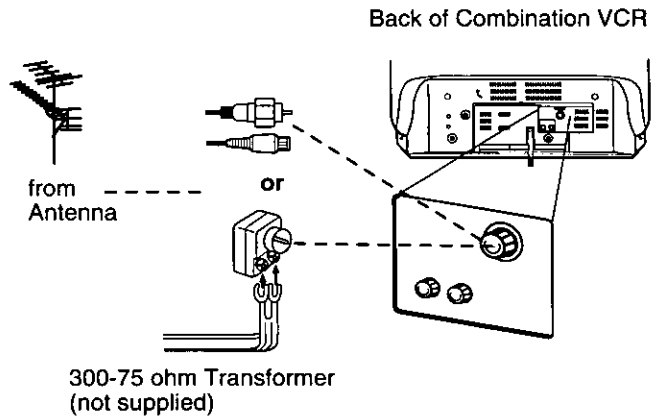

Cable Connections

(A) Without a Converter/Descrambler Box

With this connection, you can: use your Combination VCR remote control to select channels for viewing and select unscrambled channels for timer recording. Scrambled channels may not be viewed or recorded with this connection.

(B) With a Converter/Descrambler Box

With this connection, you may record and view any channel including scrambled channels. Please note, however that channel selection must be made at the cable company converter box. Timer recording is limited to one channel at a time, and you can only view the channel you are recording.

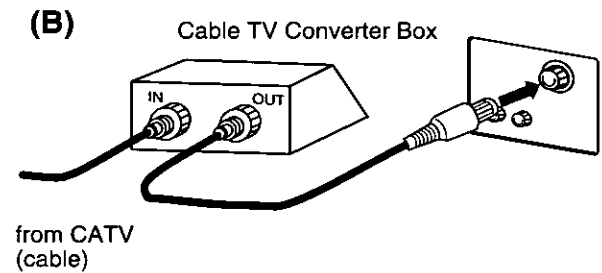
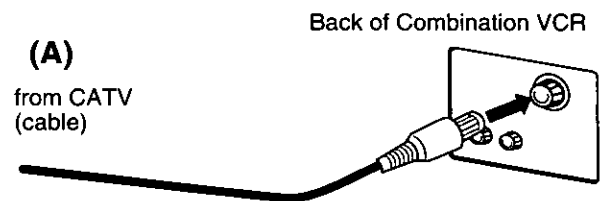

To Watch and Record Scrambled/Unscrambled Channels

Set the Combination VCR channel selector to the output channel of the cable converter box (e.g. CH3). Now, select channels to be viewed or recorded at the cable converter box.



One Time Setup



Check list before you begin.

- Your Combination VCR is connected to an Antenna, or Cable system (see page 5).
- You've read over the Select/Set Wheel operation, below.

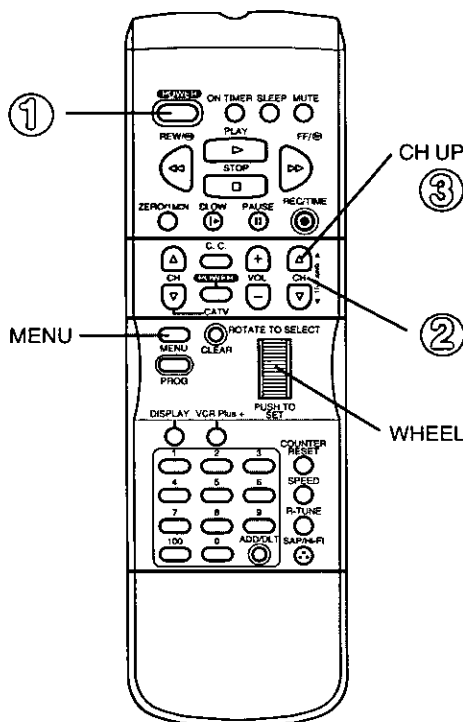
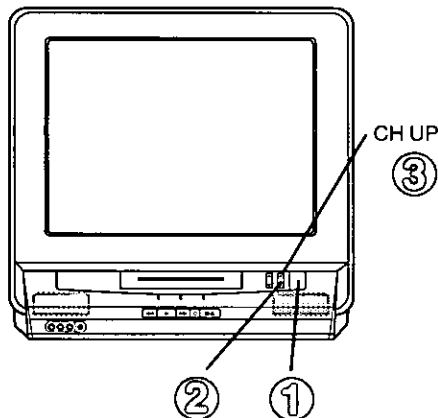

To Set Language, Channel and Clock

When the Combination VCR power is first turned on, the channel auto set and set clock screens appear automatically.



Turn the Combination VCR on.

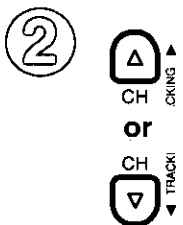

Push CH UP or DOWN for on-screen displays in English or Spanish.

- If you choose the wrong language, please see the "Reset all Combination VCR Memory Functions" section on page 28.
- If you use a cable box, the cable box must be left on for auto channel set.

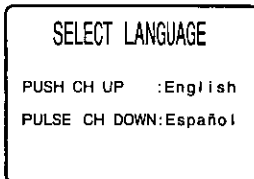

Important: If you use a cable box, turn it on and select PBS station in your time zone.



Push CH UP to start Channel Auto Set and Clock Auto Set.

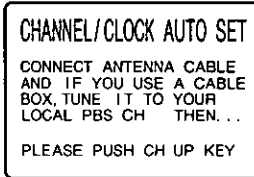

These on-screen displays will appear in sequence.

- CH AUTO SET PROCEEDING
- CH AUTO SET COMPLETED
- AUTO CLOCK SET PROCEEDING

Case 1

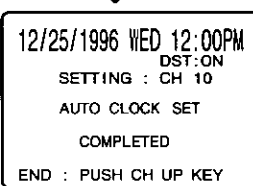

Case 2

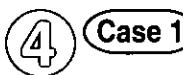
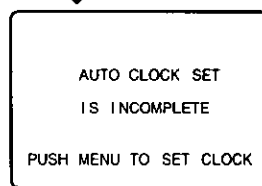

Confirm that displayed time is correct and push the CH UP button to exit.

If the displayed time and D.S.T. are incorrect, please proceed as follows:

In the rare event that you live close to two different time zones, the Combination VCR may recognize the wrong PBS station as the setting channel. In this case, please do the following:

- 1 Make a note of the SETTING:CH number shown on-screen and push the CH UP button to exit.
 - 2 Delete the setting channel from the Combination VCR channel memory. (See the Add or Delete a Channel section on the next page.)
 - 3 Push the MENU button to display the menu.
 - 4 Use the WHEEL to select "CLOCK" and then to select "AUTO SET."
- If you use a cable box and have multiple PBS stations, tune the cable box to a different PBS station and try auto clock set again using the menu.

Case 2

If the screen above appears, auto clock set is not available in your area. Please set the clock manually as described on the next page.



- To view the deleted channel, please select with the NUMBERED keys.
- If for any reason, the time is changed manually, automatic time correction will not occur.
- Auto clock set will be performed when the Combination VCR is turned off the first time each day. If you use a cable box and you want auto clock set to be performed, the cable box must be left on and the PBS channel is tuned at the Combination VCR power is turned off.

Using the Select/Set Wheel

There are basically two types of Wheel operation.

- Selecting items from an on-screen display.
- Entering information, such as setting the clock.

OPERATION

- 1 Rotate (up or down)
- 2 Push (like a button)

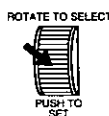
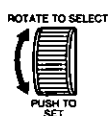

to make selection to enter selection

Manual Clock Set



Push MENU to display the set clock screen.

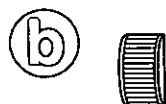
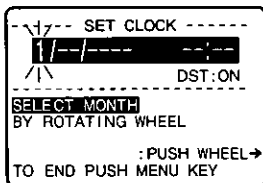

Rotate and push the WHEEL to select and enter the month, date, year, time, and D.S.T. (Daylight Saving Time).

• "DST:ON" automatically adjusts for daylight saving time. (See page 28.)

To Make Corrections, push the WHEEL or CLEAR button repeatedly to move back or forward to the desired item.



Push MENU twice to start the clock and exit this mode.

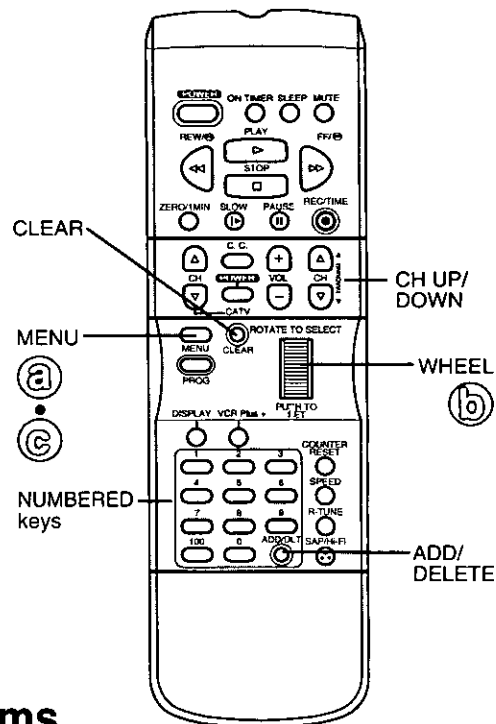

To Change or Re-enter One Time Setup Items

To Change the OSD Language

- 1 Push the MENU button to display the menu.
- 2 Rotate the Wheel to select the language selection icon.
 - "IDIOMA" is Spanish for "language."
- 3 Push the Wheel to change the language.
- 4 Push the MENU button to exit this mode.
 - To return the normal screen, select "EXIT".

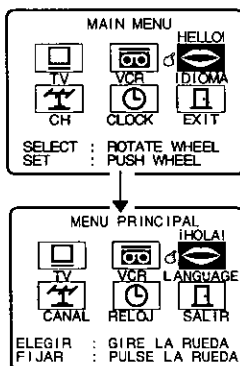

To Set or Reset the Clock

In case the clock is wrong, or a power failure occurred.

- 1 Push the MENU button to display the menu.
- 2 Rotate and push the Wheel to:
 - (A) Select CLOCK.
 - (B) Select MANUAL SET.
 - (C) Set the date, time, and D.S.T. (Daylight Saving Time).
- 3 Push the MENU button twice to start the clock and exit this mode.

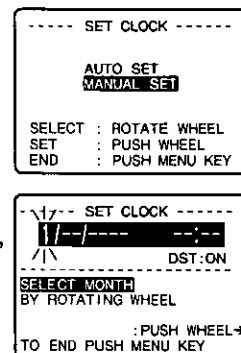

To Replace Channels in Memory

Example, if you have cable installed, etc.

- 1 Push the MENU button to display the menu.
- 2 Rotate and push the Wheel to select and set "CH" from the menu, and then push to select your antenna system (TV or CATV).
- 3 Rotate and push the Wheel to select AUTO SET.
 - To exit this mode, push the MENU button twice.

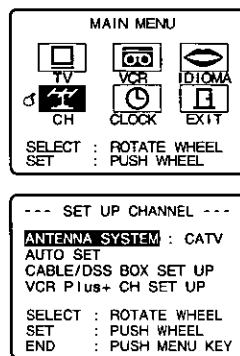

To Add or Delete a Channel

- 1 Push the CH UP/DOWN button or the NUMBERED keys to select a channel to add or delete.

The NUMBERED keys select all channels regardless of whether they have a signal or not. The CH UP/DOWN button selects only those channels which are in the Combination VCR's channel memory.
- 2 Push the ADD/DEL button to add or delete the channel.
 - To select a deleted channel, use the NUMBERED keys.

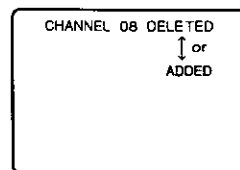

- This Combination VCR will accurately maintain its calendar up to Dec. 31, 2089, 11:59PM.
- Normal TV or Cable channels are automatically selected and placed in memory depending on how your Combination VCR is hooked up.

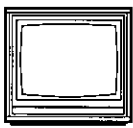

On Screen Displays (OSD)

Channel & Function Display

Whenever the channel is changed, the Channel number will appear for a few seconds on-screen. (Some station names may also appear.)

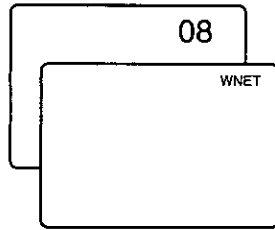

When a function button is pushed (PLAY, FF, etc.) the Combination VCR mode will be displayed.

- When a recording is started, both REC and the channel will appear together.

Menu Screen

1 Push the MENU button to display the menu.

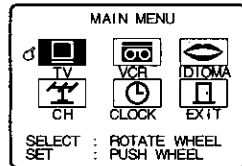

2 Rotate and push the wheel to make your selection (see page 6).

- To get the most from each feature, it is recommended that you read the Operation Manual before attempting any operation.

VCR Status & Clock Display

Push the DISPLAY button to display and remove the overlay shown below.

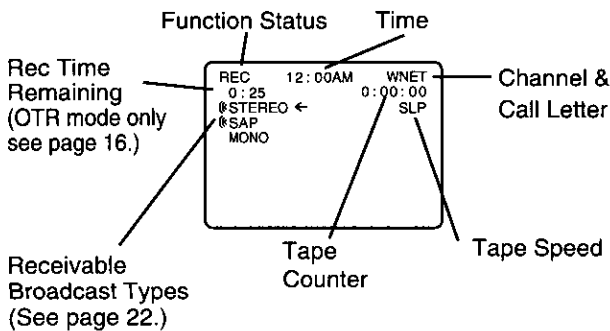

Blank Tape and will be Blue Screen

If a blank section of tape is encountered in the Play mode or the channel you select has no broadcast, the TV screen will change to a solid blue field. The screen will remain blue until a recorded signal is again detected or an active channel is selected.

Warning and Instruction Displays

These displays will alert you to a missed operation or provide further instructions.

If no active channels are found for CHANNEL MEMORY...

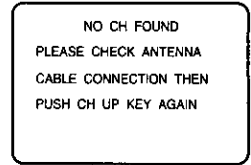

If a Timer Program was not completed before exiting the Program mode...

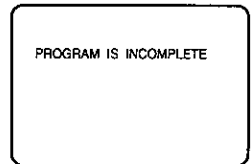

If you push the REC button on the remote control or the REC and PLAY buttons on the Combination VCR, and a cassette is inserted with no record tab...

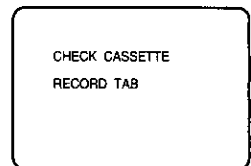

If you push the STOP button during a Timer Recording...

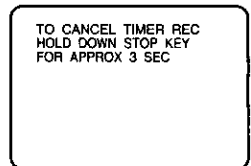

If you push the PLAY, FF, REW, or REC button on the remote control or if you push the REC and PLAY buttons, the FF, PLAY, or REW button on the Combination VCR without a cassette inserted...

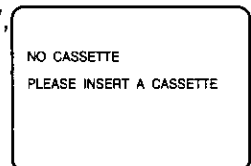

If you attempt to set or review a Timer Recording or set the On Timer and the Clock is not set...

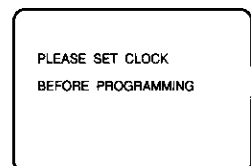

Two minutes before a Timer Recording is about to begin...





TV Operation

✓ Check list before you begin

- All connections are made. (See page 5.)
- Your Combination VCR is plugged in.



Push POWER to turn the Combination VCR on.



Select a channel using CHANNEL UP/DOWN or NUMBERED keys.

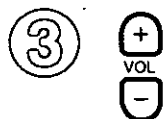

Push VOLUME UP/DOWN to adjust the volume level.

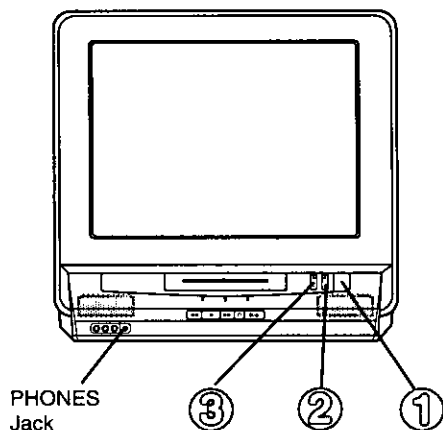

PHONES Jack

Using the 100 key

When selecting CATV channels 100 to 125 with the NUMBERED keys, first push the 100 key and then enter the remaining two digits. For example, for channel 125: Push the NUMBERED keys 100-2-5.

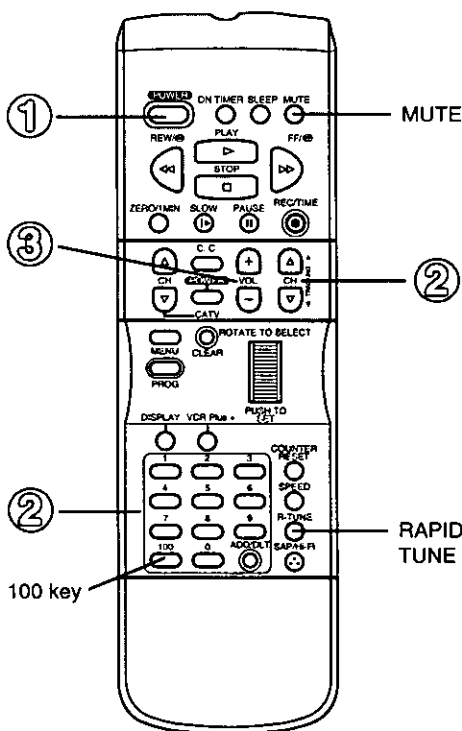

Rapid Tune

Push the R-TUNE button to display the last channel you were watching.

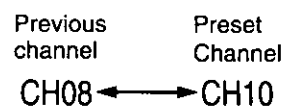

- When selecting channels with the CH UP/DOWN button, the channels must be displayed for at least 4 seconds in order for the Combination VCR to recognize them as a new selection.

Audio Mute

Push the MUTE button to instantly mute the sound. Push again, to restore the previous sound level.

Phones

Connect an earphone (not supplied) or headphone (not supplied) to the Phones Jack.

FCC WARNING: Any unauthorized changes or modifications to this equipment would void the user's authority to operate.

Note to CATV System Installer

This reminder is provided to call the CATV (Cable TV) System Installers attention to Article 820-40 of the NEC that provides guidelines for proper grounding and, in particular, specifies that the cable ground shall be connected to the grounding system of the building, as close to the point of cable entry as practical.

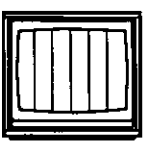



Picture Adjustment

Check list before you begin

- All connections are made. (see page 5.)
- Your Combination VCR is plugged in.

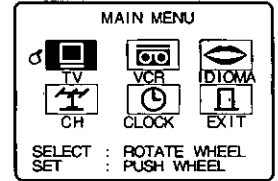
①  Push MENU to display the menu screen.



②  Rotate and push the WHEEL to first, select "TV" and then, to select VIDEO ADJUST.

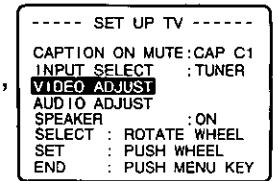

③  Rotate and push the WHEEL to select and display the desired video adjust overlay. (See description below.)

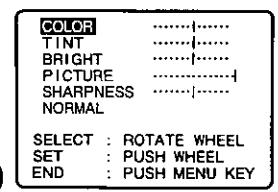

④  Rotate the WHEEL to adjust and push to set the control.

- Repeat steps 3 and 4 to adjust the picture as necessary.

⑤  Push MENU three times to exit this mode.

- If no button is pushed within 5 minutes, the video adjust overlay disappears.
- Adjustment scale and setting indicator number are displayed to assist you.

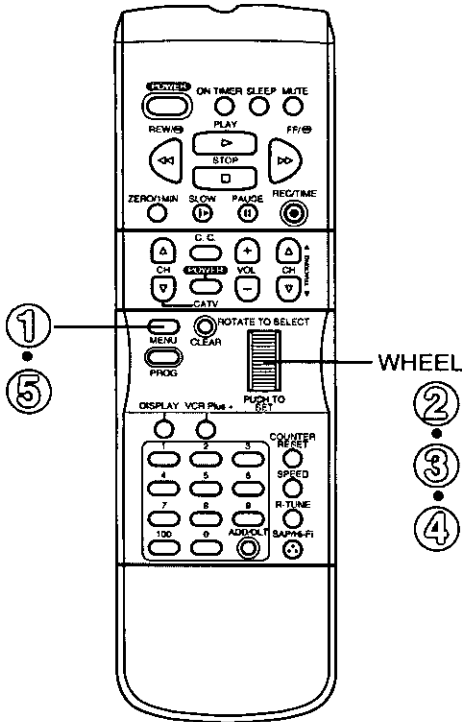

To Reset Picture Controls to the Factory Setting

Rotate and push the WHEEL to select and set NORMAL.
All controls return to factory settings.

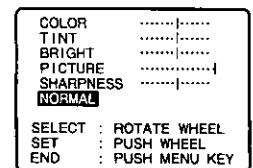

Picture Adjust

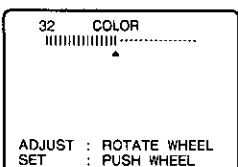

COLOR Control
To adjust the intensity of the colors.

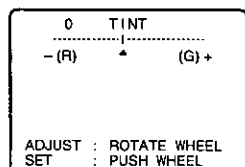

TINT Control
To adjust for the most natural flesh tones.

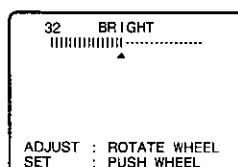

BRIGHT Control
To adjust the brightness of the picture.

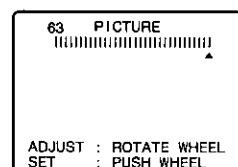

PICTURE Control
To adjust the intensity of the picture by adjusting contrast and color level at the same time and in the proper balance.

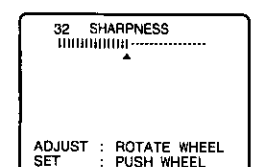

SHARPNESS Control
To adjust the sharpness of the picture.



TV Timer Features

✓ Check list before you begin.

- All connections are made (see page 5).
- Your Combination VCR is plugged in.

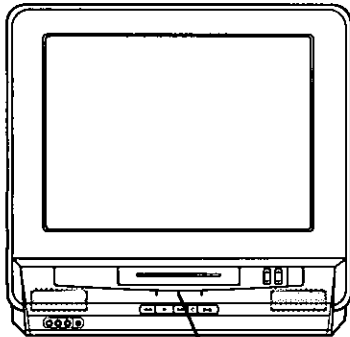

ON TIMER Indicator

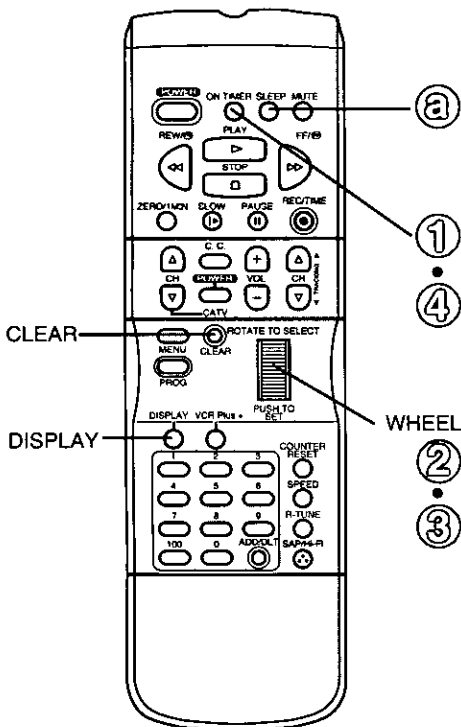

Set the On Timer

The Combination VCR can be set for auto power on.

① **ON TIMER** Push ON TIMER to display the ON TIMER.

② Rotate and push the WHEEL to set the ON time.

③ Rotate and push the WHEEL to select either a channel number for TV mode or "PLAY" for VCR Playback mode when the Combination VCR comes on.

- Make sure a tape is inserted if VCR Playback mode is selected.

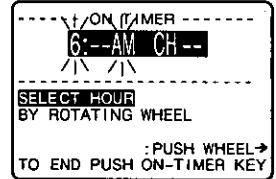

To Make Corrections,

push the Wheel or CLEAR button repeatedly to move back or forward to the desired item.

④ **ON TIMER** Push ON TIMER to set On Timer function. This screen will appear for about 5 seconds.

- The ON TIMER indicator lights on the front panel.

ON TIMER SET
CANCEL: PUSH CLEAR KEY

To Cancel,

push the CLEAR button while above screen is displayed. "ON TIMER END" will appear for about 5 seconds on-screen.



- 60 minutes after the Combination VCR turns itself on, it will turn itself back off unless any remote or Combination VCR button is pushed.

Set the Sleep Timer

The Combination VCR can be set for auto power off.

Ⓐ **SLEEP** Push SLEEP to display the desired sleep timer.

- Each push of the SLEEP button will change the overlay at right:

SLEEP TIMER 30
↓
SLEEP TIMER 60
↓
SLEEP TIMER 90
↓
SLEEP TIMER 00

- If you push the DISPLAY button with the SLEEP TIMER set, the remaining time will appear on-screen.

To Cancel,

push the SLEEP button repeatedly until "SLEEP TIMER 00" appears.

SLEEP TIMER 12

CC Closed Caption System

✓ Check list before you begin

- All connections are made. (See page 5.)
- Your Combination VCR is plugged in.

This system not only allows the hearing impaired to enjoy selected programs, but also makes valuable information from your TV stations available to you.



Push to C.C. select the desired caption mode (see below). Selected mode is displayed as an overlay on the screen.

Each push of the C.C. button will change the caption mode as follows:

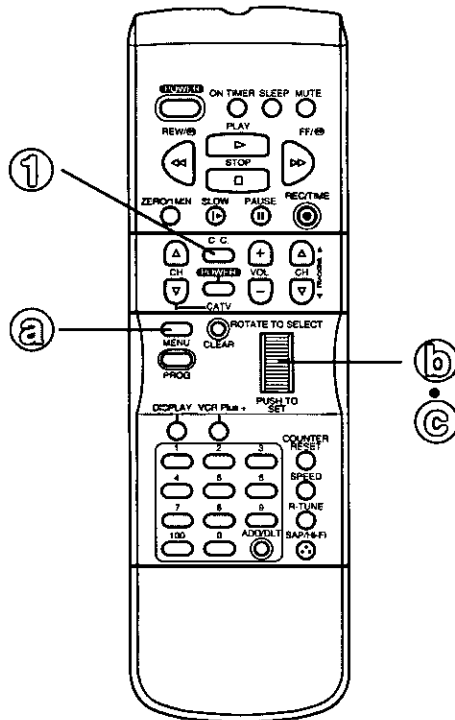
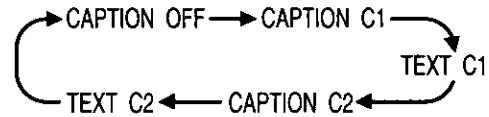

Caption On Mute Feature

This feature allows you to turn off the sound and, at the same time, display the closed caption narration. Perfect for when you need silence, but would like to continue enjoying the program.

Push MENU to display the menu.

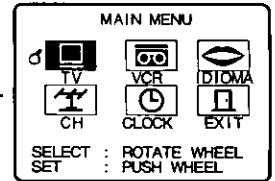

Rotate and push the WHEEL to select "TV."

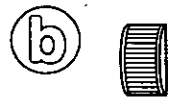

Push the WHEEL to select the desired caption mode.

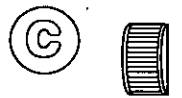

- Make sure "CAPTION OFF" using the C.C. button on the remote control.

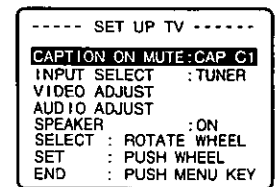

Each push of the WHEEL will change the display as shown at right.

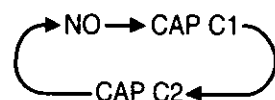

Recording and Play Back a Closed Caption/Text Program

Record: Your Combination VCR will automatically record the Closed Caption/Text signal. Just follow normal recording operation.

Playback: To display the Closed Caption narration or Text during playback, simply follow the steps listed above right.

Closed Caption Modes to Choose From

Caption Mode: CAP C1 or C2

A narration of selected TV programs will be displayed on the screen. Check your TV program listings for CC (Closed Captioned) broadcasts.

Caption Mode: TEXT C1 or C2

The lower half of the screen will be blocked out. When the TV station broadcasts text, such as program listings, special information, etc., it will appear in this space.

Caption Mode: OFF

Narration will not appear on the screen even if a closed caption or text broadcast is received.

- The closed caption or text signal may be broadcast over C1, C2, or both. Also, text contents can vary so you may wish to try different settings.

▶ Playback a Tape



Check list before you begin

- All connections are made. (See page 5.)
- Your Combination VCR is plugged in.

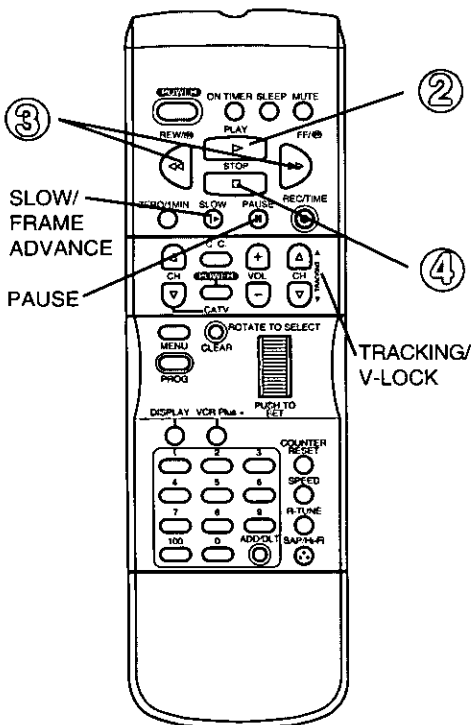
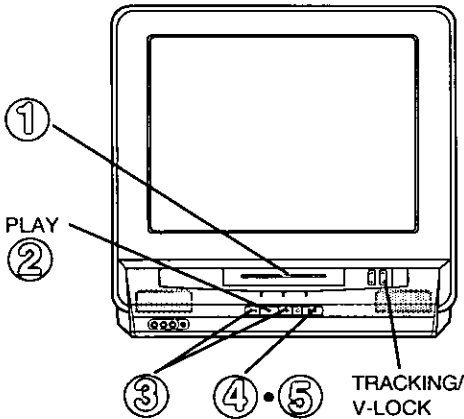

①

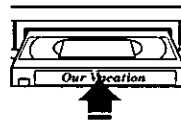

Insert a cassette.

- Combination VCR power comes on automatically.

②



Push **PLAY** to start playback.

- Playback begins if cassette has no record tab.

(Unit or Remote Control)

③



or



Push **REW** or **FF** to quickly locate a scene.

- SP mode tapes have a search speed of 9 times and SLP mode tapes 27 times the normal speed.
- Some noise bars will appear during search.

(Unit or Remote Control)

④

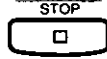

Push **STOP** to stop playback.

(Unit or Remote Control)

⑤



Push **STOP/EJECT** to eject the cassette.

- This button only on Combination VCR.

Special Effects During Playback

These features work best in SP or SLP mode. The sound will be muted. (After the Combination VCR is in the Still or Slow mode for 3 minutes, it will go into the Stop mode automatically to protect the tape and video head.)

Slow Motion Playback

Push **SLOW**. To release the Slow mode, push **PLAY** or **SLOW**.

Still (Freeze) Frame Picture

Push **PAUSE** to freeze and release the picture.

Frame by Frame Advance

While in Still mode, push repeatedly or hold down the **SLOW** button to advance the still picture one frame at a time. Push **PAUSE** or **PLAY** to release.

Feature for a Quality picture

Digital Auto Tracking

This feature continuously analyzes the signal and adjusts for optimum picture quality.

Manual Tracking Control

Use during Playback and Slow Motion mode to reduce picture noise. Push the **CH (TRACKING)** ▲/▼ buttons until the picture clears up. To return to Auto Tracking, eject and re-insert the tape.

V-Lock Control

In Still mode the **CH (TRACKING)** ▲/▼ buttons operate as a V-Lock control to reduce jitter. Push the **CH (TRACKING)** ▲/▼ until the picture is stabilized.

PanaBlack™ Picture Tube

This Combination VCR uses a PanaBlack™ picture tube for better color reproduction and picture contrast.

Caution:

Please inspect your cassette tape for any loose or peeling labels as it may become jammed in your unit.

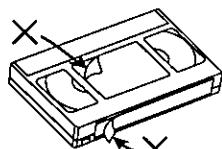



Tape Operation

Your Combination VCR is equipped with several time saving features as well as convenient automatic functions which make tape operation easier than ever.

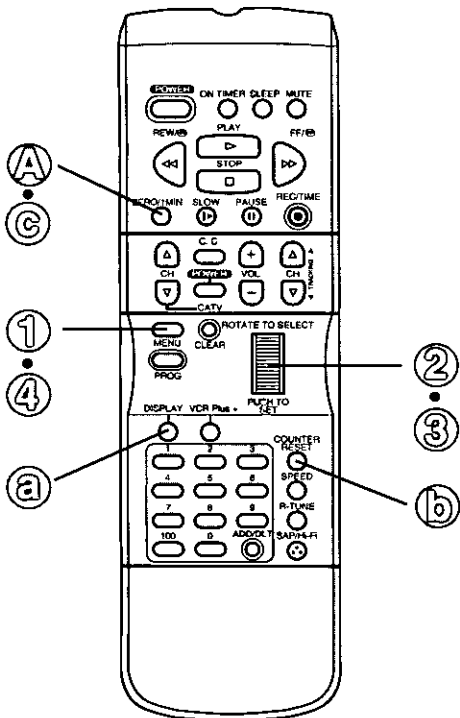

Repeat Play

You can set your Combination VCR up to play a recording over and over.

① Push MENU to display the menu.

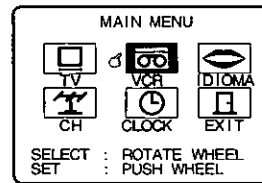

② Rotate and push the WHEEL to select "VCR" from the menu.

③ Rotate the WHEEL to select "REPEAT PLAY", then push to select "ON" or "OFF."

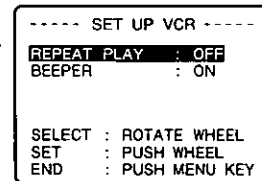

- When REPEAT PLAY : "ON" is selected, the Combination VCR will play to the end of a tape, or until it reaches a blank portion 30 seconds or more. (Erased portions of tape are not considered blank.) Then, the Combination VCR will automatically rewind the tape and play it again and again until you cancel repeat play. The REPEAT indicator lights on the front panel.
- All function buttons (REW, FF, etc.) are operational during Repeat Play.

④ Push MENU twice to exit this screen.

NOTE You may also turn the repeat play feature on and off at the Combination VCR by pushing the PLAY button once or twice until the repeat indicator lights up (ON), goes out (OFF).

Auto Operation Functions

Auto Playback

When a tape is inserted, the power comes on (Auto). If the record tab* is removed, playback begins (Auto).

Auto Rewind

After a tape reaches its end during playback or fast forward, the Combination VCR will rewind and go into Stop mode.

Playback Auto Eject

After a tape without a record tab* is played to its end, the Combination VCR will rewind and then eject the tape.

Rec Auto Eject

After a tape reaches its end during normal recording, the Combination VCR will rewind and then eject the tape.

Memory Rewind Off

When the POWER button is pushed during rewind, rewind will be completed even though the Combination VCR turns off.

Eject Cassette

A cassette may be ejected with power on or off.

* For record tab information, see page 28.

One Minute Skip

With this feature, you can skip over commercials recorded on a tape.

A Push ZERO/1MIN in Play mode.

- The Combination VCR will go into FF search mode and skip over 60 seconds of recorded time. Then, normal playback will resume.

Zero Search

You can reset the Time Counter to zero and then return to that point.

a Push DISPLAY to display the Time Counter overlay.

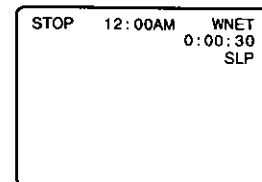

b Push COUNTER RESET to reset the Time Counter.

- Counter to 0:00:00 at whatever point you wish on the tape.

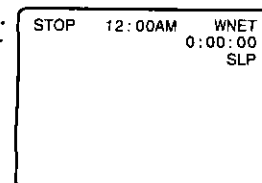

c Push ZERO/1MIN in Stop mode.

- The Combination VCR will go into FF or REW mode and stop at the last point the Time Counter was set to 0:00:00.

Record On a Tape



Check list before you begin.

- All connections are made (see page 5).
- Your Combination VCR is plugged in.

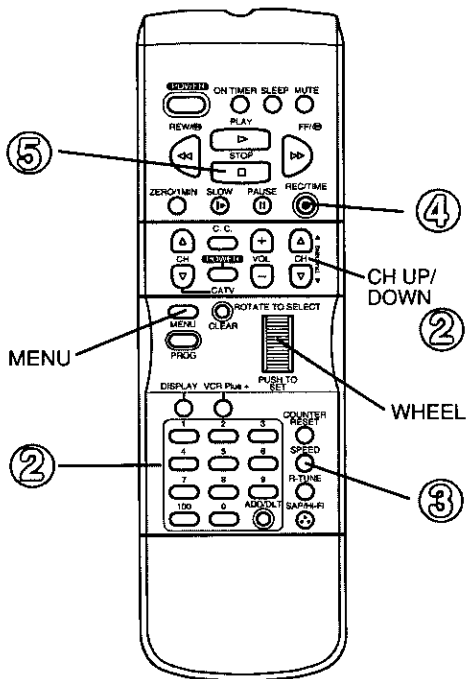
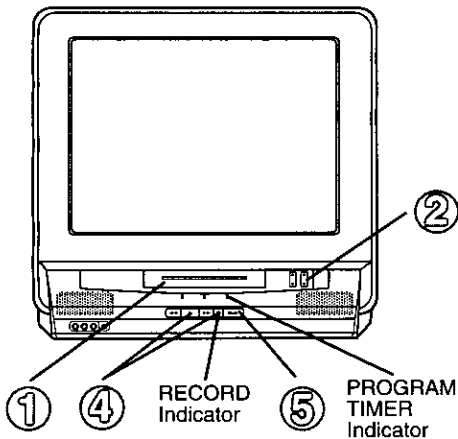

1

Insert a cassette with record tab.

- The Combination VCR power comes on automatically.

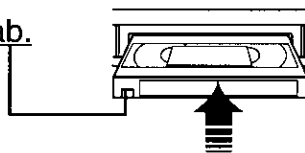

2



Push CH UP or DOWN or NUMBERED keys to select a channel.

- Or, push the CH Up/Down button on Combination VCR.
- To record from an outside source, push the CH UP/DOWN to select LINE (see below).

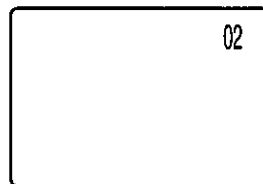

3



Push SPEED until the desired speed appears on-screen.

- SP = Standard Play, LP = Long Play, SLP = Super Long Play.

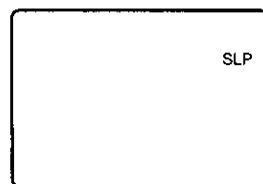

4



Push REC/TIME to start recording.

- Or, push the PLAY and REC/TIME buttons on Combination VCR.

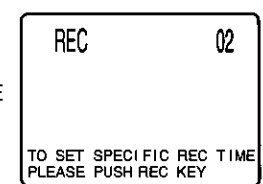

One Touch Timer Recording (OTR)

The Combination VCR stops recording at a preset time.

Continue to push the REC/TIME button to set the recording length. Each Push will change the time as shown.

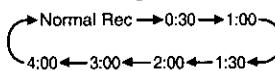

- PROGRAM TIMER indicator lights on the front panel.
- Push the PAUSE button to pause a One Touch Recording in progress.

TO SET SPECIFIC REC TIME PLEASE PUSH REC KEY

After 2 seconds

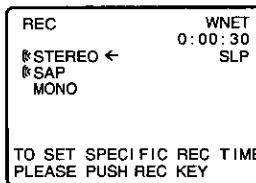

TO SET SPECIFIC REC TIME PLEASE PUSH REC KEY

5



Push STOP to stop recording.

- Or, push the STOP button on Combination VCR.

Selecting the Input Mode

You can select the Input Mode In one of two ways.

- Push the CH UP/DOWN button. The display will change in the order below.

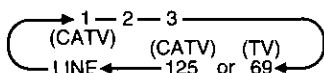

- Push the MENU button to display the menu. Then, use the WHEEL key to select "TV" and then "INPUT SELECT" Finally choose "TUNER" or "LINE."



- While it is possible to change the tape speed when you are recording, there will be some distortion on the tape where the change occurred.
- Push PAUSE to pause a recording in progress. (After the Combination VCR has been in Rec Pause mode for 5 minutes, it will stop automatically to protect the tape and video head.)
- The recording time remaining will appear when the DISPLAY button is pushed during OTR mode.

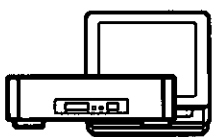

Copying Your Tapes (Dubbing)

Connections you'll need to make.

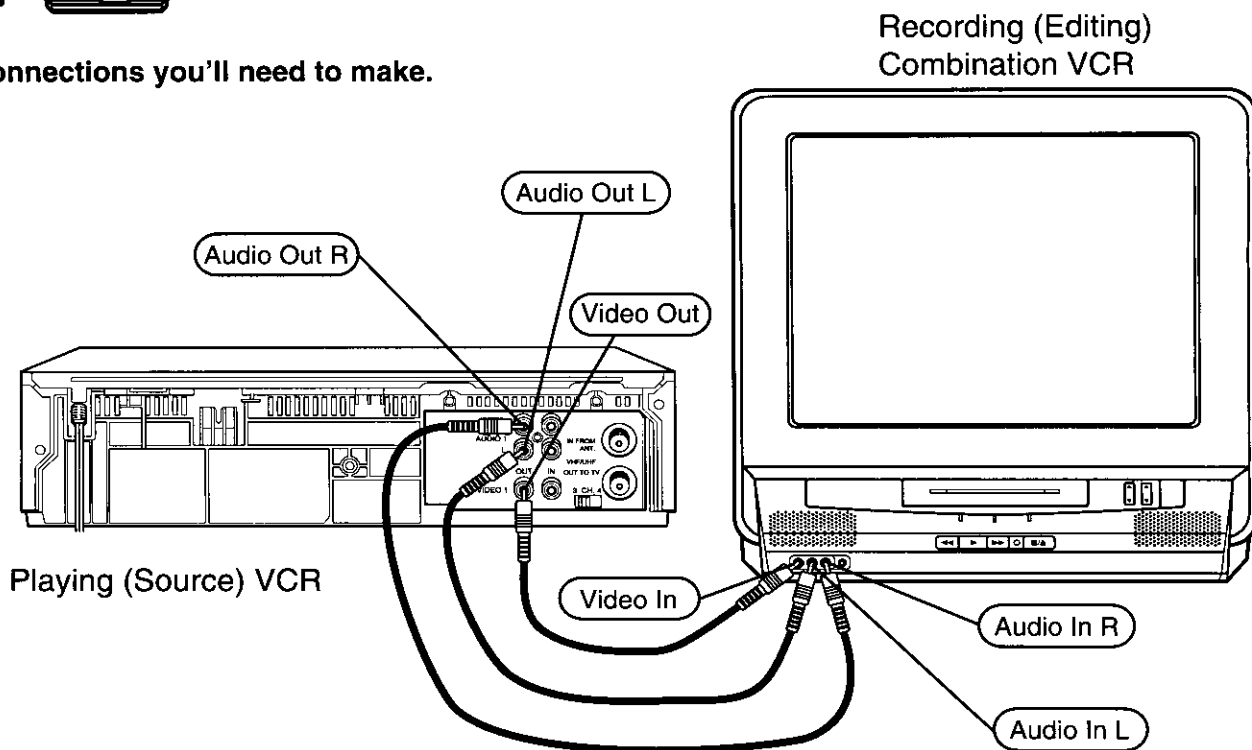

- 1 Insert a pre-recorded tape into the Playing (source) VCR.



- 2 Insert a blank tape with record tab into the Recording (editing) Combination VCR.

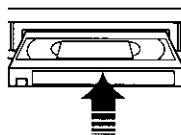

- 3 Select "LINE" as the input on the Recording Combination VCR.
 - If you are using this Combination VCR as the Recording unit, see "Selecting the Input Mode" section on page 16.

- 4 Push **PLAY** on the playing VCR. Then, push **PAUSE** when the tape reaches the point you want to start copying.

- 5 Push **REC** and **PLAY** at the same time on the recording Combination VCR. Then, push **PAUSE** on the remote immediately.

- 6 Push **PAUSE** on both units (at the same time), to begin copying.

Edit Out Unwanted Parts of the original recording by using the PAUSE button (on the Recording unit) while copying is in progress.

- 7 Then, push **STOP** on both units to stop copying.

Caution:

Unauthorized exchanging and/or copying of copyrighted recordings may be copyright infringement.



Timer Recording

Your Combination VCR can be set up to do a recording while you are away or otherwise occupied. Up to 8 programs can be placed in memory. You can choose to record one time, daily, or weekly.



Check list before you begin.

- All connections are made. (See page 5.)
- Your Combination VCR is plugged in.
- The clock is set.
- The tape is long enough.
- The record tab is in place.

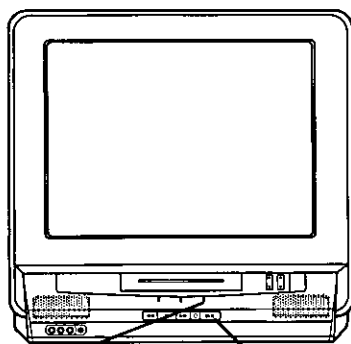

PROGRAM
TIMER indicator

STOP/
EJECT

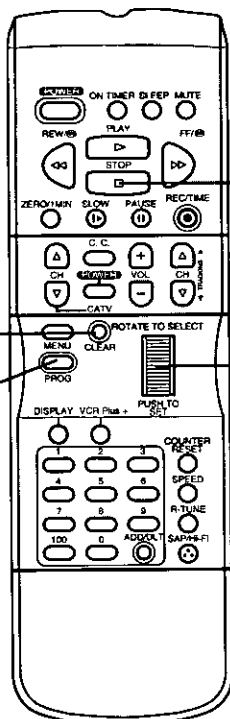

CLEAR

PROG

STOP

WHEEL

②

③

①



PROG

Push PROG to display the program screen.

- If a program is already in memory, use the Wheel to select an unused program number.

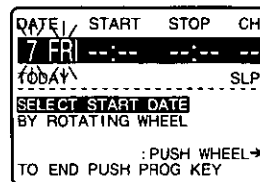

②



Rotate and push the WHEEL to select and set the DATE.

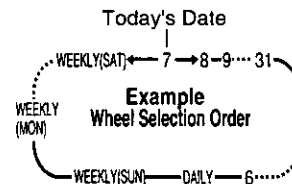

Daily and Weekly Timer Recording

If you want the program to be recorded daily (Mon thru Fri), enter DAILY in place of the DATE in step 2. If you want the recording to be on a weekly basis, enter WEEKLY MON, TUE, etc..

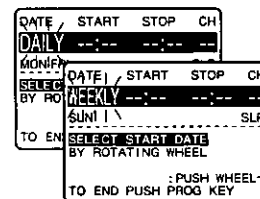

③



Rotate and push the WHEEL to select and set remaining items at right.

Remaining items to be set:

- START time
- STOP time
- CH(annel) number, or LINE for outside source recording.
- Speed (SP, LP, SLP).

To Make Corrections

Repeatedly push the Wheel to move forward, or the CLEAR button to move back to the desired item.

④



PROG

Push PROG to end the program.

- If you want to enter more programs, select a blank program number with Wheel and repeat steps 2 and 3.

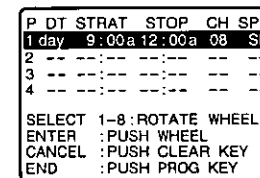

⑤



PROG

Push PROG to exit this mode.

- The PROGRAM TIMER indicator lights on the front panel.

- If you're using a cable box, make sure that it is tuned to the desired channel and the power is left on for timer recording.

Two minutes before the Timer Recording starts, "TIMER REC WILL START SOON" will appear on-screen.



- If "PLEASE PREPARE FOR TIMER REC" appears and/or the PROGRAM TIMER indicator flashes, check that a cassette with record tab is loaded and the Combination VCR is in Stop mode.
- If the start times of two programs overlap, the lower numbered program will have priority.
- If the start time for a timer recording comes up during a normal recording or One Touch Recording (page 16), the timer recording will not be performed.
- If there is a power interruption of more than one minute, the recording may not be performed or continue.
- If "PROGRAM IS INCOMPLETE" appears on-screen in step 4, check all entries and make necessary corrections.

Cancel a Timer Recording: Recording is in progress

Hold down the STOP button for a few seconds to cancel the Timer Recording.

- Any future daily or weekly recordings will be performed as programmed.

Replace Program Contents: Recording is not in progress

1 Push the PROG button to display all currently set programs.

P	DT	STRAT	STOP	CH	SPD
1	--	--	--	--	--
2	8	10:00p	12:00p	125	SLP
3	10	8:00p	9:00p	10	SP
4	SU	9:00p	10:00p	L	SLP

SELECT 1-8: ROTATE WHEEL
ENTER : PUSH WHEEL
CANCEL : PUSH CLEAR KEY
END : PUSH PROG KEY

2 Rotate and push the Wheel to select and enter the desired timer recording. (See page 18.)

DATE	START	STOP	CH
8 SAT	10:00P	12:00P	125
/ / / / /			
SELECT START DATE BY ROTATING WHEEL			
←PUSH CLEAR : PUSH WHEEL→ TO END PUSH PROG KEY			

3 Rotate and push the Wheel to select and enter replacement information.

4 Push the PROG button to exit this mode and return to the normal TV screen.

Review or Clear Program Contents: Recording is not in progress

1 Push the PROG button to display all currently set programs.

P	DT	STRAT	STOP	CH	SPD
1	day	9:00a	12:00a	08	SP
2	8	10:00p	12:00p	125	SLP
3	10	8:00p	9:00p	10	SP
4	SU	9:00p	10:00p	L	SLP

SELECT 1-8: ROTATE WHEEL
ENTER : PUSH WHEEL
CANCEL : PUSH CLEAR KEY
END : PUSH PROG KEY

2 Rotate the Wheel to select the desired program number.

P	DT	STRAT	STOP	CH	SPD
1	--	--	--	--	--
2	8	10:00p	12:00p	125	SLP
3	10	8:00p	9:00p	10	SP
4	SU	9:00p	10:00p	L	SLP

SELECT 1-8: ROTATE WHEEL
ENTER : PUSH WHEEL
END : PUSH PROG KEY

3 Push the CLEAR button to clear the program.

4 Push the PROG button to exit this mode and return to the normal TV screen.

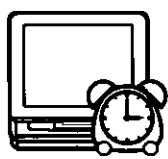

Timer Recording Using Unit Buttons

A timer recording can be set up using the buttons on the Combination VCR. If necessary, the clock can also be set.

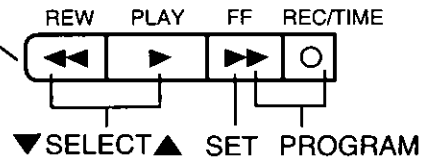
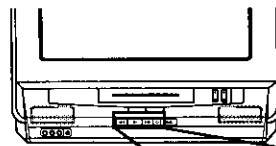

1



Hold down REC/TIME.

DATE	START	STOP	CH
7 FRI	--:--	--:--	--
/ / / / /			
fobay SLP			
SELECT START DATE BY SELECT ▲/▼ KEY			
NEXT, PUSH SET KEY OR TO END PUSH PROG KEY			

and



Push FF to enter the program mode.

- If the clock is not set, pushing these buttons will display the SET CLOCK screen. In this case, set the clock according to the OSD's instructions and then set a timer recording.

SET CLOCK	
AUTO SET	MANUAL SET
SELECT	: PUSH SELECT ▲/▼
SET	: PUSH SET KEY
END	: PUSH PROG KEY

- Once the Combination VCR is in the Program mode, the PLAY, REC, FF, and REW buttons on the Combination VCR operate only as specified above.

2

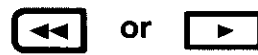

Push REW or PLAY to make your selection.

(for down) (for up)

3



Push FF to set and move on to the next item.

Items to be Set:

- recording DATE
- START time
- STOP time
- CH(annel), or LINE
- SPEED (SP, LP, SLP)

- Push SET (FF) repeatedly to move to a particular item for setting or correction.

When the program is completed...

4



Push REC/TIME and FF to display program contents.

(at the same time)

To set the next program, repeat steps 2, 3, and 4 before continuing with step 5.

5



Push REC/TIME and FF to exit this mode.

(at the same time)

- It is not possible to clear a timer program using the Combination VCR buttons. Please use the Remote Control.

SPECIAL Special VCR Features



Check list before you begin

- All connections are made (see page 5).
- Your Combination VCR is plugged in.

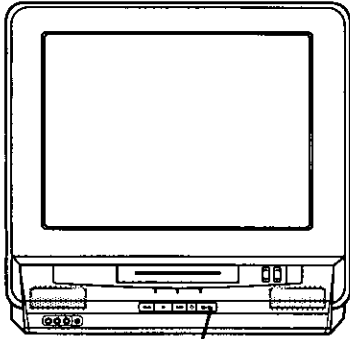

STOP/EJECT

VCR Lock Feature

When activated, this feature prohibits all operations except for timer recording, and tape eject. This is useful to prevent misoperation and protect your Combination VCR from curious children.

STOP/EJECT



Hold down STOP/EJECT on the Combination VCR for 7 seconds during Stop, or Power OFF mode.

VCR LOCK ACTIVATED

To Cancel the VCR Lock feature,

STOP/EJECT



Hold down STOP/EJECT on the Combination VCR for 7 seconds again during Stop, or Power OFF mode.

VCR LOCK OFF

- VCR Lock mode is cancelled automatically after 24 hours when the clock is set.
- This feature cannot be activated or canceled when a timer or one touch recording is in progress.

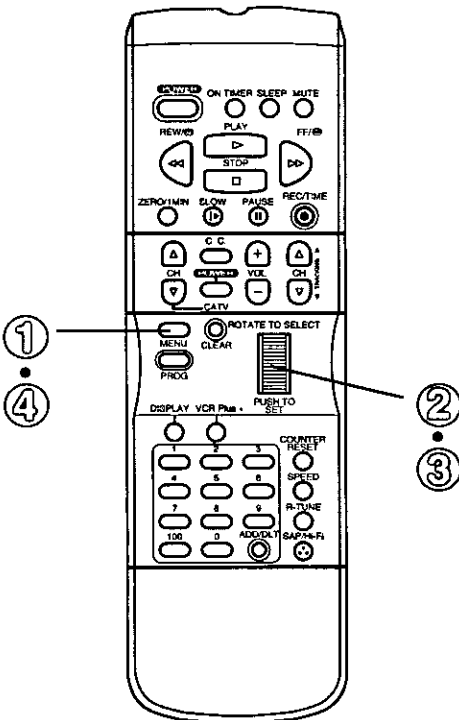

Warning Beeper Feature

When you select BEEPER ON as described below, a short warning will sound each time an invalid entry or operation is made and a timer program is set.

1



Push MENU to display the menu.

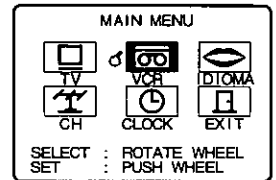

2



Rotate and push the WHEEL to select "VCR".

3



Rotate the WHEEL to select "BEEPER", then push to select "ON" or "OFF".

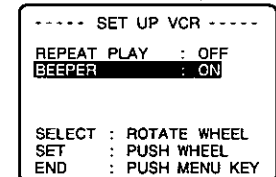

4



Push MENU twice to exit this screen.

Speaker On/Off System

Allows you to turn off the speaker of the Combination VCR when it is connected to external audio equipment.



Push MENU to display the menu.

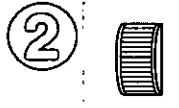
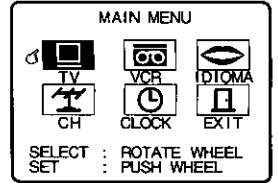

Rotate and push the WHEEL to select "TV".

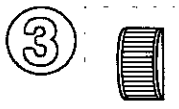

Rotate the WHEEL to select "SPEAKER" and push to turn the speaker off or on.

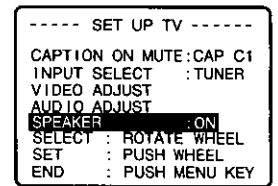

Push MENU twice to return to the normal screen.

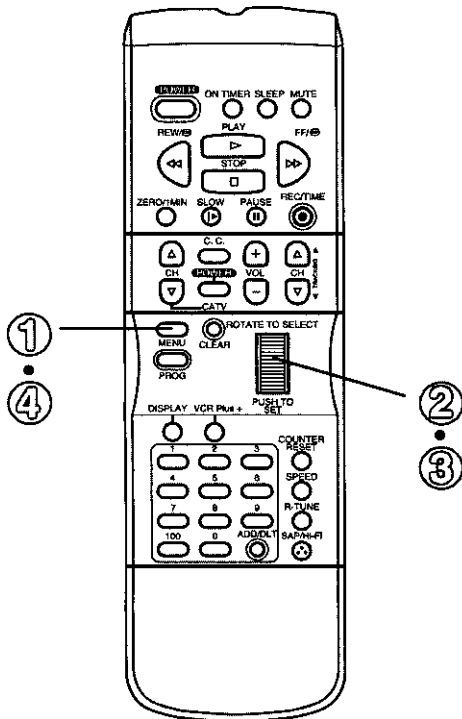

- In SPEAKER OFF condition, the mute and volume Up/Down buttons do not function. The screen at right appears if these buttons are pressed in SPEAKER OFF mode.

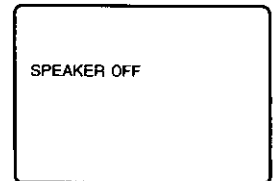

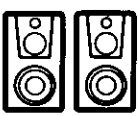

MTS Broadcast/VHS Hi-Fi Stereo System



Check list before you begin

- All connections are made (see page 5).
- Your Combination VCR is plugged in.

Receivable Broadcast Types

The following are possible broadcast types with their accompanying on-screen displays. The signal is indicated with an "Ⓢ" mark while the selected audio mode is indicated with an arrow. To change the audio mode for listening to these broadcasts, follow "Select Audio mode for TV viewing" section.

DISPLAY



Push DISPLAY to display the broadcast signal currently being received on-screen.

MTS Stereo and SAP broadcast

Multi-channel Television Sound Stereo (main language) and Second Audio Program (second language) broadcasts are being received simultaneously. Select the STEREO or SAP audio mode as desired.

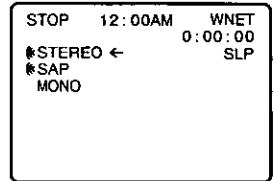

MTS Stereo broadcast

Multi-channel Television Sound Stereo broadcast is being received.

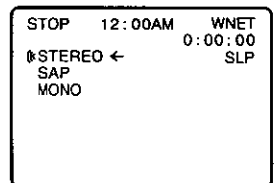

SAP broadcast

Second Audio Program (second language) broadcast is being received. Select SAP audio mode for the second language.

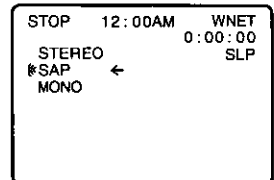

MONO broadcast

Normal monaural sound broadcast is being received.

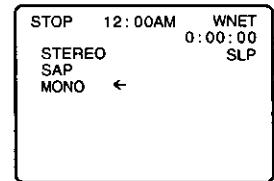

- If a stereo broadcast is weak and the display flickers, you may want to select the MONO audio mode for better results.

- Your tapes can be played back on Hi-Fi as well as non-Hi-Fi Combination VCRs because the audio mode sound you select is always recorded on the Hi-Fi tracks as well as the normal monaural track.

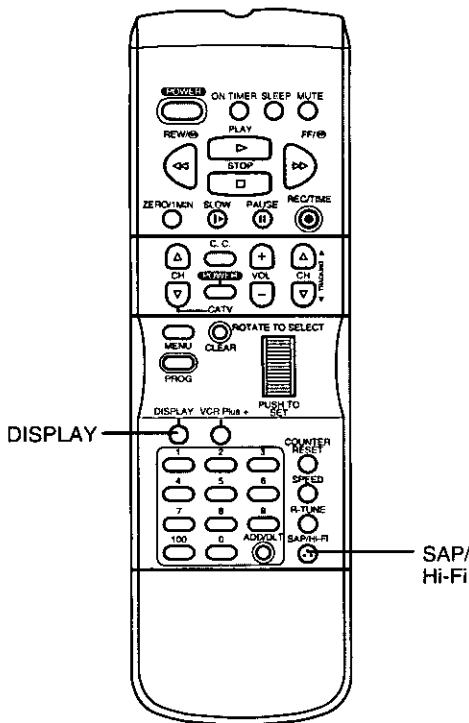

Select Audio Mode for TV Viewing

SAP/Hi-Fi



Push SAP/Hi-Fi to select the desired audio mode as described above.

- Each push of the SAP/Hi-Fi button will change the audio mode as shown below.

Example:

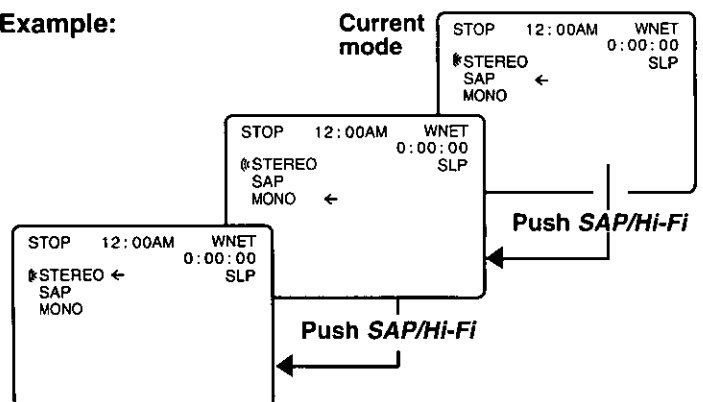

Equipped with **dbx**[®]-TV Noise Reduction for true MTS reproduction. **dbx**[®]-TV Noise Reduction is required for good stereo separation and audio fidelity. **dbx**[®] is a registered trademark, and is licensed by **dbx**[®] Technology Licensing.

With the proper audio mode setting, your Combination VCR can:

- record and playback an MTS stereo broadcast (main language) in stereo Hi-Fi. Stereo sound is recorded on the left and right audio tracks and on the video portion of a tape.
- record and playback a monaural broadcast (main language) or a SAP (Sound Audio Program, usually in a second language) on the Hi-Fi tracks for better quality monaural sound.
- playback non-Hi-Fi tapes in monaural.

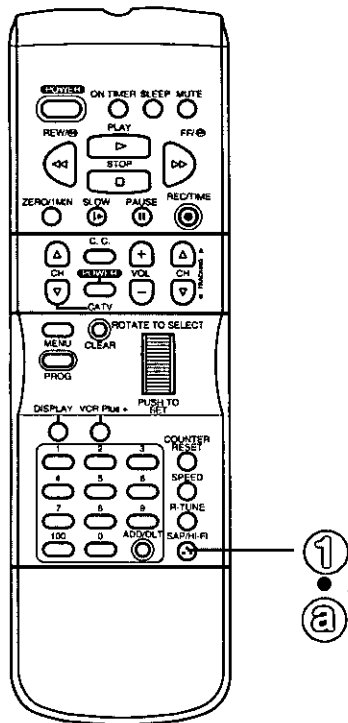

Select Audio Mode for Playback

Select the type of sound track you desire for playback.



Push SAP/Hi-Fi repeatedly (each press within 5 seconds) to select the desired audio mode (HIFI/NORMAL).

- Please select HIFI to listen to your stereo recordings with stereo sound or MONO for monaural sound.

Example:

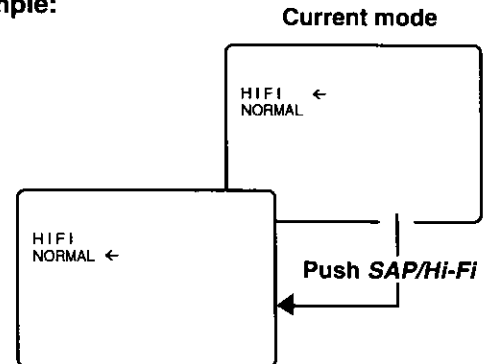

- This screen appears when push the SAP/Hi-Fi button during playback.

- ② Playback the tape.
See the "Playback a Tape" section on page 14.

Select Audio Mode for Recording

Select the type of broadcast and sound track you wish to record.

- Ⓐ Do the operation of "Select Audio Mode for TV Viewing" section on previous page.

- Your recording is always performed according to the audio mode you selected in the "Select Audio Mode for TV Viewing" section on previous page.

- Ⓑ Do a recording.
See the "Record On a Tape" section on page 16.



- When purchasing or renting prerecorded tapes, remember that only those recorded in Hi-Fi stereo will play back with true stereo sound. Standard stereo tapes will play back with monaural sound.
- If the stereo broadcast has a weak signal, you may get better results if the AUDIO MODE is set to MONO for recording. Also, set to MONO if the STEREO indicator on the front panel flickers.
- In order to listen to Hi-Fi stereo playback, the Combination VCR AUDIO (L/R) jacks must be connected to a stereo amp and speakers.
- There may be a difference in audio level between Hi-Fi and normal audio playback.

In order for your Combination VCR to do a VCR Plus+ recording (see top of page 25 for explanation of VCR Plus+), or a timer recording of cable stations, some setup is required. First, find the antenna or cable connection that matches yours. Then, follow the instructions below for your connection.

Choose your Connection Type

(Then, follow the instructions under the diagram.)

Connection Type A

<CABLE BOX → COMBINATION VCR>

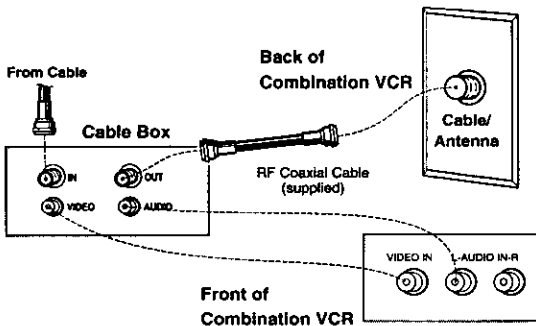

If your system looks like this diagram, do the following.

1. Complete the "Cable Box Set Up" section at right.
2. Skip page 25 and go directly to page 26 for VCR Plus+ Programming.

Connection Type B

<CABLE or ANTENNA → COMBINATION VCR>

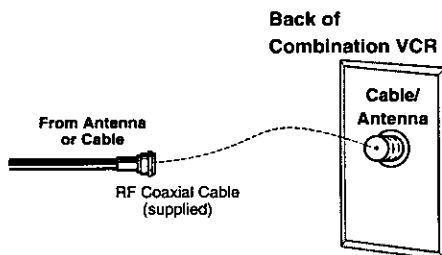

If your system looks like one of these, do the following.

1. Skip the "Cable Box Set Up" section at right and turn to page 25.
2. Complete the "VCR Plus+ Channel Set Up" section on page 25.
3. Turn to page 26 for VCR Plus+ Programming.

VCR Plus+ and PlusCode are trademarks of Gemstar Development Corporation. The VCR Plus+ system is manufactured under license from Gemstar Development Corporation.

Cable Box Set Up

For connection A (see left) only

1



Push MENU to display the menu.

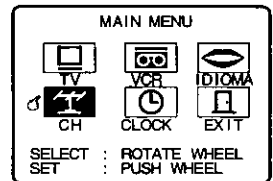

2



Rotate and push the WHEEL to select "CH."

3



Rotate and push the WHEEL to select CABLE BOX SET UP.

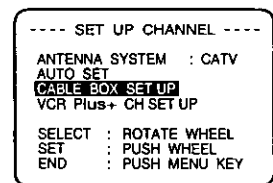

4

Select YES if all channels are received via the cable box (connection "A" at left). Then, go to step 5.

Select NO if your cable connection resembles connection "B" at left.

Push MENU to exit and turn to page 25.

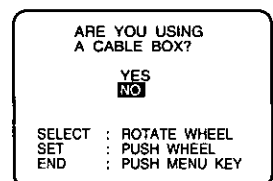

5



Rotate the WHEEL to change the output channel number.

• Number shown is example only. Be sure to enter your cable box output channel.

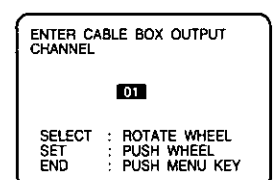

- If necessary, refer to your cable box manual.
- If you are using Audio/Video jack connection for your cable box, select and set "VIDEO OUT" as the output channel.

6



Push MENU to confirm your entry.

• This display appears for five seconds. (Channel shown is example only)

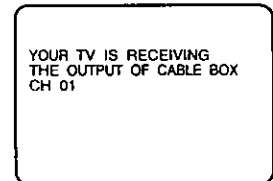

7



Push MENU twice to return to the normal screen.

Then, go directly to VCR Plus+ Programming on page 26.

VCR Plus+ programming allows you to set most items of a timer recording by simply entering a special code found in *TV GUIDE* magazine as well as the TV listings in selected newspapers. In order for the Combination VCR to read this special code, some set up is required. A Guide (VCR Plus+) channel number is assigned to each local broadcast and cable station. Because this number sometimes differs from the channel your TV receives the station on, it is necessary to program the Combination VCR with local channel information.

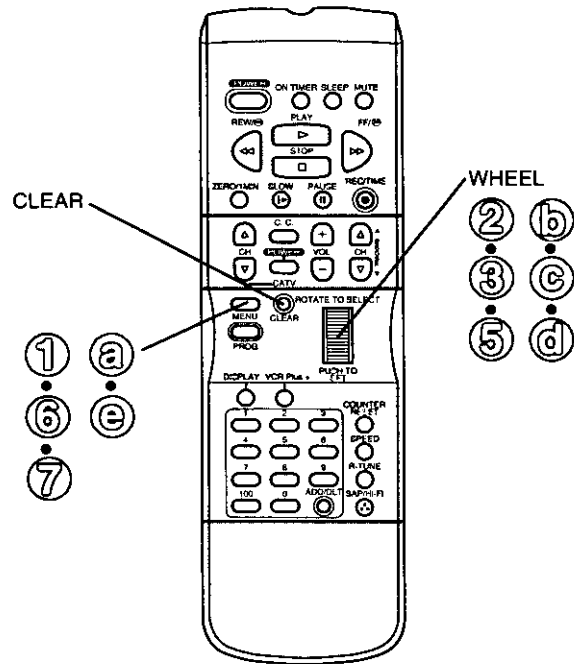

VCR Plus+ Channel Set Up (For connection B on page 24 only)

(a) Push **MENU** to display the menu.

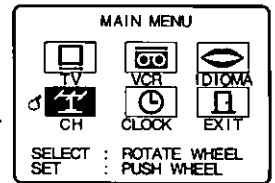

(b) Rotate and push the **WHEEL** to select "CH".

(c) Rotate and push the **WHEEL** to select **VCR Plus+ CH SET UP**.

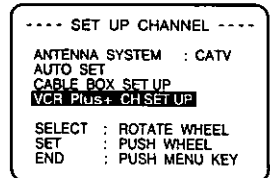

IMPORTANT NOTE:
For this step, use the list you prepared. You may leave lines blank if, you don't receive that station, or the **GUIDE CH** number and the **CATV (or TV) CH** numbers are the same.

(d) Push the **WHEEL** to move the shaded area on the right side.

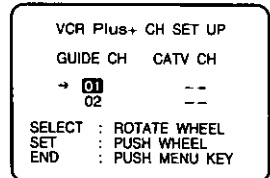

Then, Rotate the Wheel to change **CATV CH** number.
Next, Push the Wheel to enter **CATV CH** number.
Now, Rotate the Wheel to continue. Repeat this operation until the list is complete.

To Make Corrections

Rotate and push the Wheel to select the incorrect **CATV** or **TV CH** number. Then, Push **CLEAR** to delete the numbers. Now, use the Wheel to re-enter the channel.

(e) Push **MENU** twice to exit the **VCR Plus+ CH SET UP** mode.



- Make your entries within 5 minutes or the Combination VCR will leave this mode.
- Once local channels have been programmed, they will stay in memory, even in the case of a power failure.

Channel Set Up Preparations

NOTE: Complete the steps on this page if your VCR hook-up resembles "B" on page 24.

Prepare a list like the example below.

This list will help you smoothly enter the information needed in step (d) at right.

You will need the following to complete the list:

- A line up of normal and/or cable stations you receive along with the channel numbers your TV receives them on. A cable channel line-up chart is supplied by your cable company.
- A list of Guide (VCR Plus+) channel numbers assigned to the stations you receive. This list is available in *TV Guide* and the TV listings found in selected newspapers.

- 1 Make a chart with 3 columns like the example below. In the left column, fill in the name or call letters of the stations you receive.
- 2 In the middle column, fill in each station's assigned Guide (VCR Plus+) number found in *TV Guide*, newspapers, etc.
- 3 In the right column, fill in the channel number that your TV receives the station on from your channel line-up.

EXAMPLE ONLY

Broadcast or Cable Station Name	Assigned Guide (VCR Plus+) channel no.	Channel no. your TV receives the station on
HBO	33	15
Nickelodeon	38	20
CBS	04	04
FOX	11	



VCR Plus+ Programming

✓ Before you begin, make sure...

- The clock is set.
- VCR Plus+ Set Up is complete (See pages 24, 25).

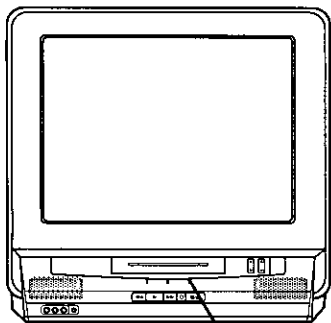

PROGRAM
TIMER Indicator

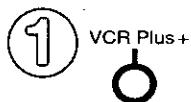
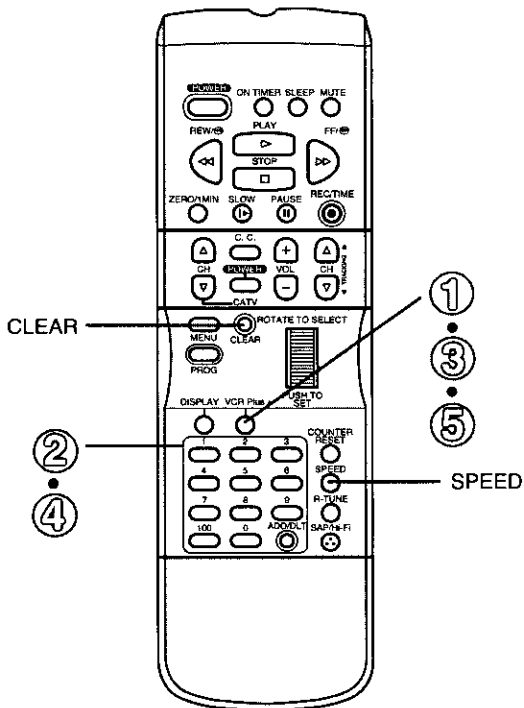

Push VCR Plus+ to display the VCR Plus+ screen.

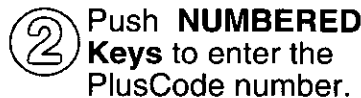
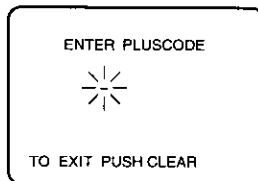

Push **NUMBERED** Keys to enter the PlusCode number.

- Refer to your local TV listings.

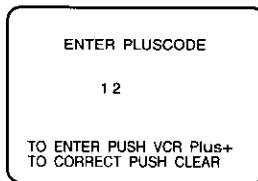

To Make Corrections

Push the CLEAR button repeatedly to delete the PlusCode number. Then, enter the correct number.



Push VCR Plus+ to lock in your program.

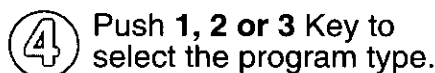

Push **1, 2 or 3** Key to select the program type.

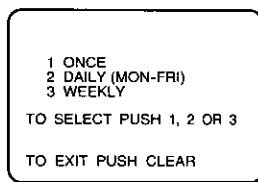

To change the recording speed:
Push the SPEED button for SP, LP or SLP.

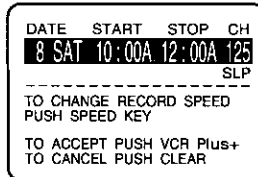

To cancel program contents:
Push the CLEAR button.

- If you use "A" connection on page 24, the channel shown in the on-screen display in this step will always be the cable box output channel number.



Push VCR Plus+ to complete the program.

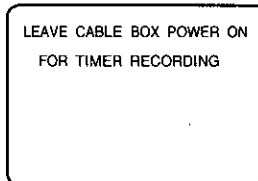

- The PROGRAM TIMER indicator lights on the front panel.
- If you're using a Cable Box, make sure that it is tuned to the desired channel and the power is left on for timer recording.

- This display appears if you use a cable box.

Use normal Timer Recording steps if:

- the PlusCode for a program is not listed.
- you anticipate the program, such as a sporting event, to run over the scheduled stop time.

See page 19 to:

- Cancel a timer recording in progress
- Replace program contents
- Review or Clear program contents once set



- For a list of publications that carry the PlusCode numbers in your area, call 1 - 800 - 258 - 4827.
- You can obtain unlisted PlusCode numbers by calling 1 - 900 - 454 - 7587. Call costs approximately \$.95 per minute.
- Avoid overlapping program times.
- An on-screen display will indicate if an invalid PlusCode number has been entered.
- An on-screen display will indicate when all timer programs are full.

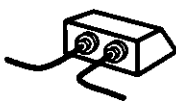

Cable Box Universal Remote Control Operation

Cable Box Code Numbers

Archer	01, 29, 44, 88, 91
Cableview	4, 30, 42, 44, 52, 63, 85, 88
Citizen	4, 30, 42, 44, 52, 63, 85, 88
Curtis	08, 09, 56, 61, 87, 90
Diamond	01, 29, 44, 88, 91
Drake	37
Eagle	13, 20, 22, 26, 40, 58, 62, 98
Eastern	28
GC Brand	4, 30, 42, 44, 52, 63, 85, 88
Gemini	04, 85
General Electric	57
General Instruments	
.....	01, 02, 03, 04, 34, 55, 83, 85, 91, 93, 95
Hamlin	14, 15, 28, 41, 97
Jerrold	
.....	01, 02, 03, 04, 34, 55, 83, 85, 91, 93, 95
Macom, Hitachi	31, 79
Magnavox	25, 26
Matsushita	16, 17
Movietime	32, 38, 40
Movietime	29, 32, 39, 42, 44, 88
NSC	32, 38, 40
Oak	46
Panasonic	16, 17
Philips	13, 20, 23, 24, 96
Pioneer	05, 06, 78
Pulser	4, 30, 42, 44, 52, 63, 85, 88
RCA	16, 17
Realistic	44, 88
Regal	14, 41
Regency	28
Rembrandt	29, 32, 39, 42, 44, 88
Samsung	32, 40, 42, 78, 94
Scientific Atlanta	08, 09, 56, 61, 87, 90
Sheritech	27
SL Marx	32, 40, 42, 78, 94
Sprucer	16, 17
Stargate	32, 40, 42, 78, 94
Stargate	4, 30, 42, 44, 52, 63, 85, 88
Sylvania	19
Telecaption	77, 92
Television	32, 40, 42, 78, 94
Texscan	18, 19
Tocom	01, 33, 34, 42, 48, 49, 91
Toshiba	36
Unika	01, 29, 44, 88, 91
Universal	42, 43, 44, 52, 63, 88
Viewstar	13, 20, 22, 26, 40, 58, 62, 98
Videoway	07, 23, 50
Zenith	07, 23, 50

The Remote Control may be set up to control some of the functions on your Cable Box.

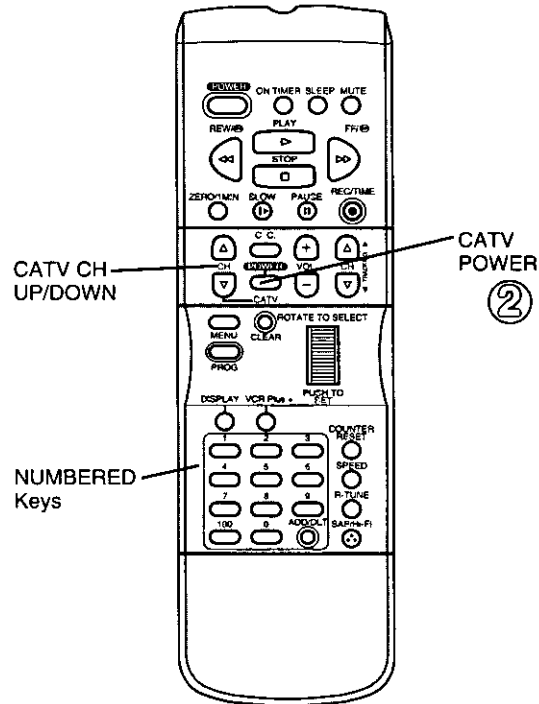

① Find your Cable Box Brand Code Number from the chart at left.

②  Hold down CATV POWER and enter your Cable Box brand code number using the NUMBERED keys.

③ Try each of the following functions with this remote control. Some Cable Box brands require you to turn on the power manually.

- POWER ON/OFF
- CHANNEL UP/DOWN

• Depending on your Cable Box model, not all functions listed may be controlled by this remote.



- Please repeat the Cable Box Set Up procedure when you replace the remote's batteries.
- Due to changes in infra-red commands used by some manufacturers, some Cable Box brands are listed more than once. If your Cable Box does not respond with the first code, please try entering the next code.
- The remote control is designed to control the brands listed. However, it will not operate all Cable Boxes made by these manufacturers. If you get no results, your particular product brand cannot be controlled by this remote.

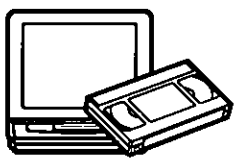

Unit and Cassette Information

Erase Protection (Record Tab)

Cassettes have a record tab to ensure that recordings are not accidentally erased.

To prevent accidental erasure, break off the tab with a screwdriver.



To record again, cover the hole with cellophane tape.



Maximum Record/Playback Time

Only use tapes with the **VHS** mark in this unit.

Tape Speed Position	Type of Video Cassette		
	T60	T120	T160
SP (Standard Play)	1 Hour	2 Hours	2 Hours 40 Minutes
LP (Long Play)	2 Hours	4 Hours	5 Hours 20 Minutes
SLP (Super Long Play)	3 Hours	6 Hours	8 Hours

Cleaning Care for Video Heads



Clogged Video Head Picture

or

Blue Back
(During playback of pre-recorded tape)

Blue Back Screen

Clogged Video Heads

While your Combination VCR will not normally require head cleaning, however the heads may become clogged when playing an old or damaged tape. If the image on your screen resembles the illustration on the left or the screen becomes solid blue when playing back a recorded signal on the tape, the heads probably require cleaning.

Cleaning the Heads

It is recommended that head cleaning be performed by a qualified service technician. Please contact your nearest Panasonic Service Center. An alternate solution is to obtain a head cleaning cassette. Be sure to follow the cleaning instructions carefully. Excessive use of a cleaning cassette could shorten head life. Use this cassette only when symptoms occur.

Reset all Combination VCR Memory Functions

This operation is convenient when moving the Combination VCR to a new location, or if a mistake was made in the One Time Setup section. Make sure a tape is not inserted in the Combination VCR.

- 1) Push the POWER button to turn the Combination VCR on.
- 2) Push and hold both the PLAY and REWIND buttons on the Combination VCR for more than 5 seconds.
 - The power will shut off.
- 3) Perform the One Time Setup section on page 6.

D.S.T. (Daylight Saving Time)

Spring:

First Sunday in April (DAYLIGHT SAVING TIME:AUTO)
Automatically adds one hour and adjusts the clock.

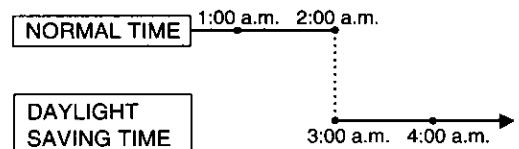

Autumn:

Last Sunday in October (DAYLIGHT SAVING TIME: AUTO)
Automatically turns back one hour and adjusts the clock.

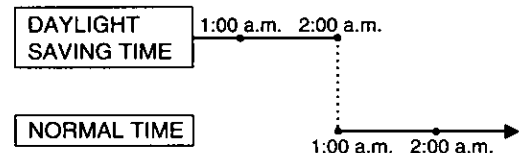

Product Specifications

Display

Picture Tube: 20 inch measured diagonal 90° deflection Picture Tube

VCR

Video Recording System: 4 rotary heads helical scanning system
Audio Track: 1 track (Normal)
2 channel (Hi-Fi Audio Sound)

Tuner:

Broadcast Channels: VHF 2-13, UHF 14-69
CATV Channels: Midband A through I (14-22)
Superband J through W (23-36)
Hyperband AA-EEE (37-64)
Lowband A-5-A-1 (95-99)
Special CATV channel 5A (01)
Ultraband 65-94, 100-125

General

Power Source: 120V AC, 60 Hz
Power Consumption: Approx. 110 watts (Power on)
Approx. 7 watts (Power off)
Television System: EIA Standard NTSC color
Speaker: 2 pieces
Operating Temperature: 41°F-104°F(5°C-40°C)
Operating Humidity: 10%-75%
Weight: 54 lbs. (24.5 Kg)
Dimensions: 21-1/8" (W) X 21-3/16" (H)
X 19-1/16" (D)
536 (W) X 538 (H) X 484 (D) mm

Note: Designs and specifications are subject to change without notice.



Before Requesting Service

Check the following points once again if you are having some trouble with your Combination VCR.

Power	Correction
No power...	<ul style="list-style-type: none"> • Check that the Power Plug is completely inserted to an AC outlet. • Check that the POWER button is set to on.
Monitor	Correction
<p>No picture or sound...</p> <p>Poor picture with normal sound...</p> <p>Poor sound with normal picture...</p> <p>Poor TV reception...</p> <p>No color or poor color...</p> <p>Ghosts (Multiple images)...</p> <p>TV programs can't be watched...</p>	<ul style="list-style-type: none"> • Make sure your antenna or cable system is connected to the Combination VCR. (P.5) • Check that the power plug is completely connected to an AC outlet. • Check that the POWER button is set to on. • Adjust the BRIGHT, SHARPNESS, and PICTURE controls in the SET UP TV menu. (P.11) • Adjust the VOLUME control. (P.9) • Adjust the SHARPNESS and PICTURE controls in the SET UP TV menu. (P.11) • Adjust the TINT and COLOR controls in the SET UP TV menu. (P.11) • Install a directional antenna. • Make sure that the channel being received is in the Combination VCRs memory. (P.6)
VCR	Correction
<p>TV program can't be recorded...</p> <p>Cannot record a stereo or SAP broadcast...</p> <p>Timer recording can't be performed...</p> <p>There's no playback picture or the playback picture is noisy or contains streaks...</p> <p>VCR can't be controlled...</p>	<ul style="list-style-type: none"> • Make sure your antenna or cable system is connected to the Combination VCR. (P.5) • Make sure that the record tab on the back of the cassette is still intact. (P.28) • This unit is not designed for stereo/SAP broadcast recording. • Set the recording start/stop time correctly. (P.18-19) • Timer recording may not be performed or continued if a power interruption of more than 1 minute occurs before or during Timer Recording, even if power resumes thereafter. • Adjust the TRACKING control slowly in either direction. (P.14) • Make sure that VCR LOCK is set to off. (P.20)
Remote Control	Correction
Combination VCR can't be remote controlled...	<ul style="list-style-type: none"> • Aim the Remote Control directly at the remote sensor on the Combination VCR. (Refer to Control Reference Guide.) • Avoid all obstacles which may interfere with the signal path. • Inspect or replace the batteries. (P.4) • Make sure that VCR LOCK is set to off. (P.20) • Exposing the Combination VCR remote sensor to direct fluorescent or outdoor light may cause signal interference.
Miscellaneous	Correction
<p>Video cassette can't be inserted...</p> <p>Video cassette can't be removed...</p> <p>Eject does not function or insertion cannot be done...</p> <p>Video cassette ejects when the REC and PLAY buttons are pushed or when the two minutes before the Timer Recording starts...</p> <p>In the stop mode, the motor (CYLINDER) continues to rotate...</p> <p>VCR can't be controlled...</p>	<ul style="list-style-type: none"> • Insert the cassette with the window side up and the record tab facing you. • Check that the power plug is completely connected to an AC outlet. • Turn the POWER off and then on, and try ejecting or inserting the tape again. • Make sure the record tab on the back of the cassette is still intact. (P.28) • To enable the quick play mechanism, the cylinder will rotate for about 5 minutes. • The quick play mechanism reduces response time from Stop to Play mode and from Play to Rewind search mode. • Make sure that VCR LOCK is set to off. (P.20)



Index of Controls

Remote Control Button

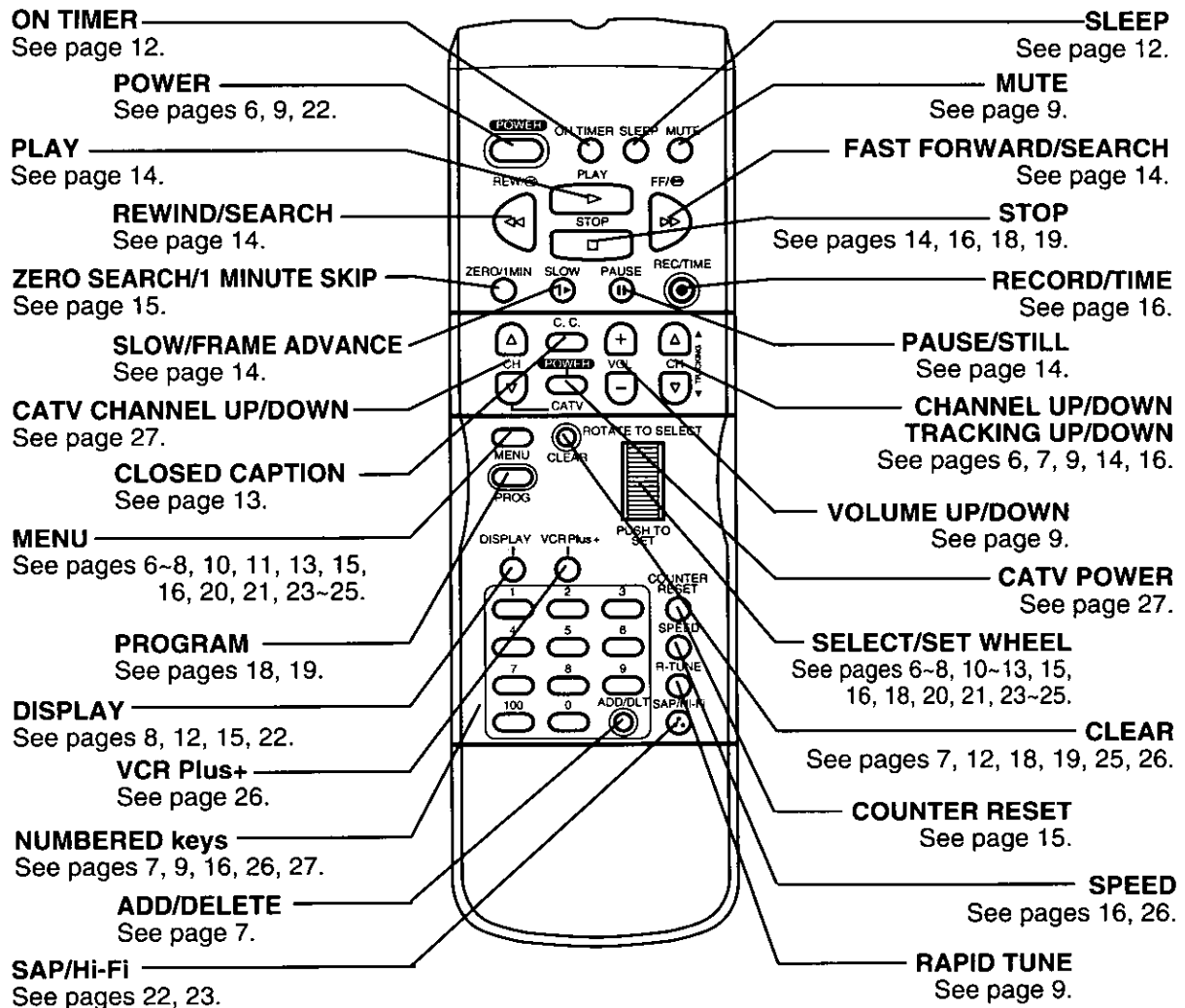

Indicators on the Front Panel

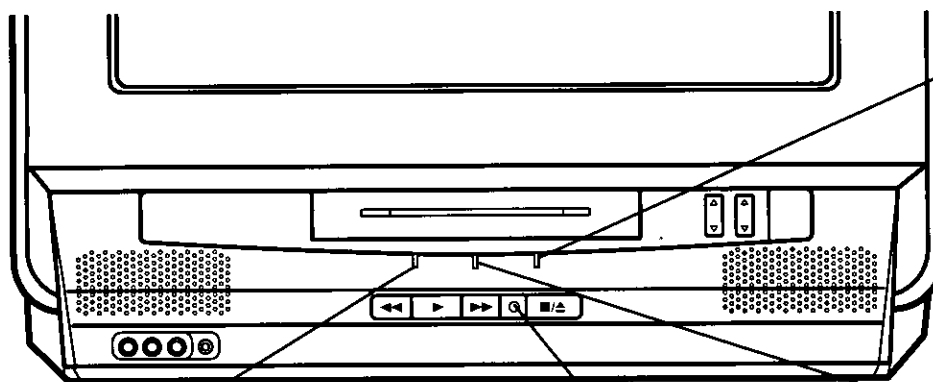

REPEAT Indicator
Lights when "REPEAT PLAY: ON" is selected and playback is in progress. See page 15.

RECORD Indicator
Lights during recording. In Rec Pause or OTR Pause mode, the indicator flashes. See page 16.

ON TIMER Indicator
Lights when the On Timer is set. See page 12.

PROGRAM TIMER Indicator
Lights when the Combination VCR is set for Timer Recording. It flashes when a Timer Recording has been set, but a tape has not been inserted, the clock is not set, or the tape is in motion. See pages 16, 18, 26.

Front View of the Combination VCR

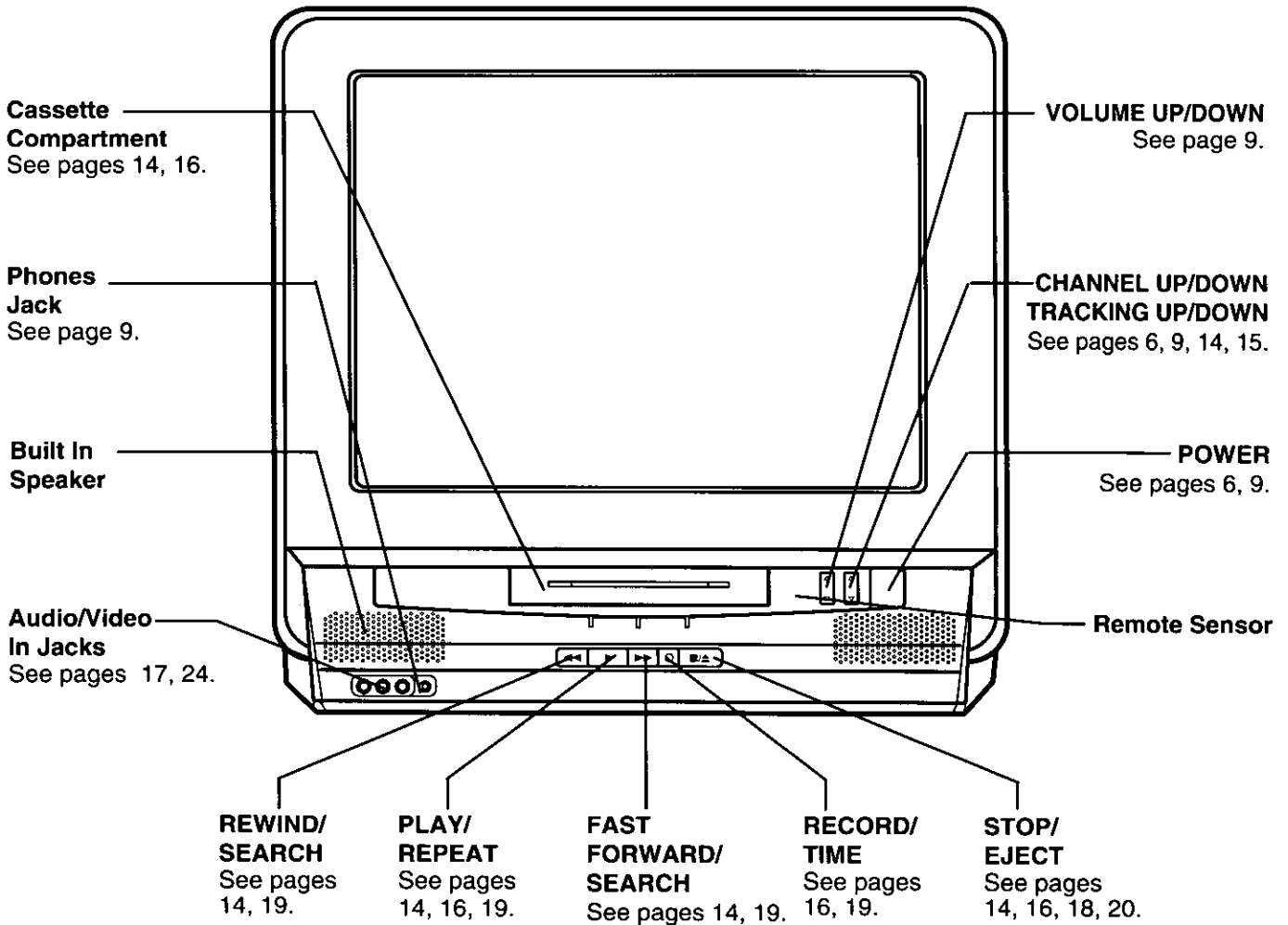

Rear View of the Combination VCR

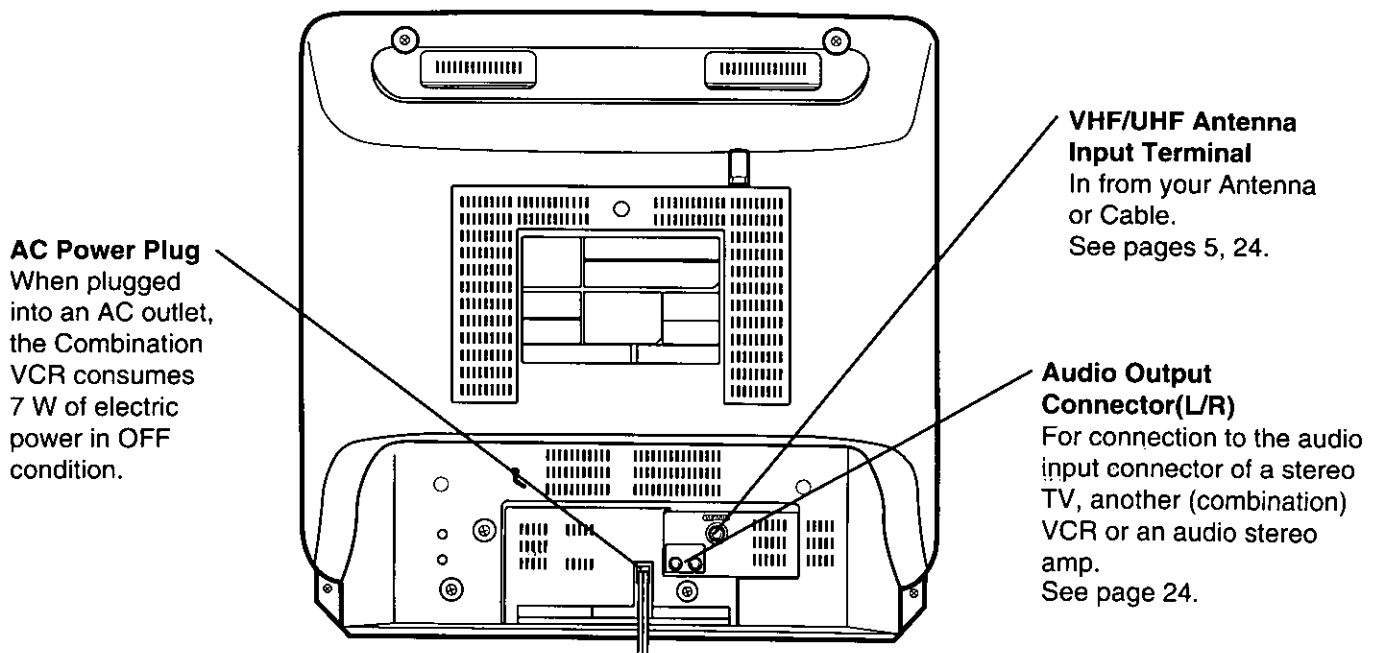

Conexión de la antena externa

Desenganche la antena del televisor o registrador de video que tuviera anteriormente y conéctela a la parte trasera del Registrador de Video de Combinación, como se muestra en el diagrama. Si el sistema de su antena tiene conductores UHF y VHF separados, usted necesita un Mezclador de Banda UHF/VHF (no viene con el equipo).

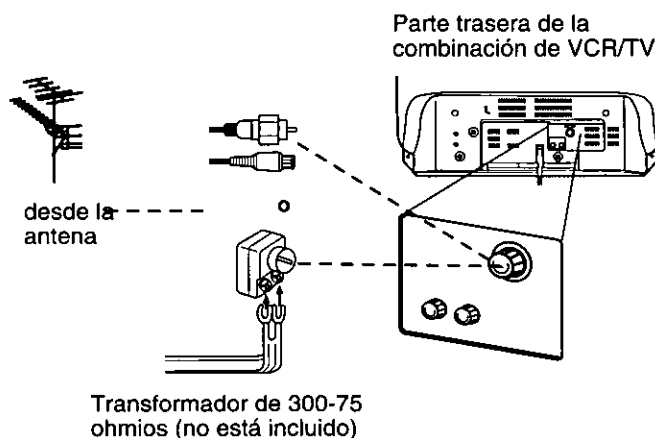

Conexiones de TV por cable

(A) Sin la caja convertidora/decodificadora

Con esta conexión usted podrá utilizar su control remoto del Registrador de combinación de VCR/TV para seleccionar los canales que desee ver y seleccionar canales no codificados para su grabación programada. Esta conexión no permite ver ni grabar canales codificados.

(B) Con una caja convertidora/decodificadora

Con esta conexión, usted podrá grabar y ver cualquier canal, incluyendo los canales codificados. observe, sin embargo, que la selección de canales se debe efectuar en la caja convertidora de TV por cable que suministra esta empresa. La grabación programada está limitada a un canal cada vez, y sólo se podrá ver el canal que esté grabando.

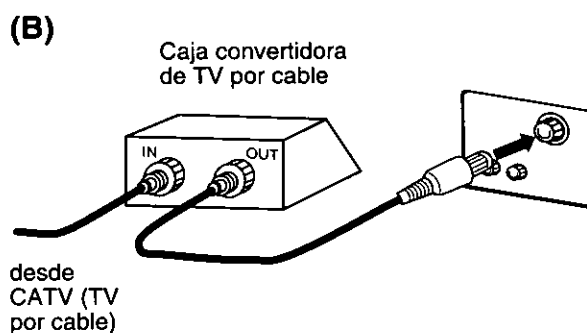
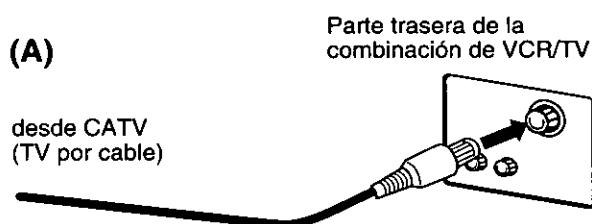

Para ver y grabar un canales codificado/no codificado

Coloque el selector de canal del Registrador de combinación de VCR/TV en el canal de salida de la caja convertidora de televisión por cable (por ejemplo el canal 3). Después, seleccione en la caja convertidora de TV por cable los canales que se quieran ver o grabar.

Para fijar el idioma, canal y reloj

Al encender la combinación de VCR/TV por primera vez, aparecerán las pantallas para fijar automáticamente los canales y el reloj.

1  Encender la combinación de VCR/TV.

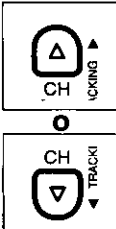
2  Oprimir CH UP o CH DOWN para elegir el idioma de la pantalla en inglés o español.

SELECT LANGUAGE

PUSH CH UP :English

PULSE CH DOWN:Español

3 **Importante:** Si está usando una caja de TV por cable, encienda la caja y sintonice al canal PBS de su zona.

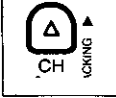
 Oprimir CH UP para iniciar la fijación de los canales y el reloj.

FIJACION AUTO. (CA/RELOJ)

CONECTE EL CABLE DE LA ANTENA Y SI ESTA USANDO UNA CAJA DE TV POR CABLE SINTONICE AL CANAL PBS DE SU LOCAL LUEGO...

POR FAVOR OPRIMIR CH UP

Las siguientes informaciones aparecerán seguidamente:

- AUTOPROGRAMACION EN PROCESO
- AUTOPROGRAMACION COMPLETO
- FIJACION AUTOMATICA DEL RELOJ EN PROCESO

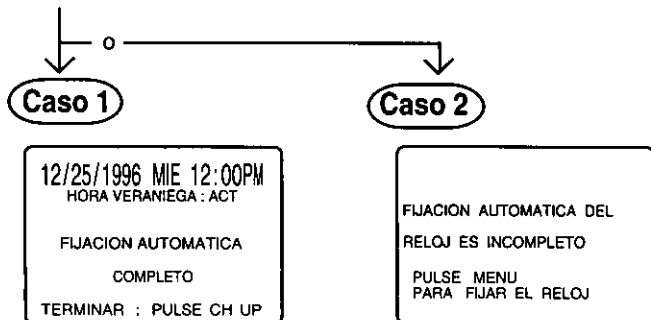

4 **Caso 1** Comprobar si la hora está fijada correctamente y luego oprimir CH UP para terminar la fijación.

Si la hora y la hora veraniega es incorrecta, por favor siga los siguientes pasos:

Raras veces, en caso de que ud. vive cerca de dos zonas con hora diferente, el aparato puede elegir un canal PBS con diferente hora de su zona. En este caso, haga los siguientes pasos:

- 1 Tome nota del canal que está fijado en la pantalla y salga desde este modo oprimiendo el botón CH UP.
- 2 Anule este canal desde los canales memorizados en la combinación de VCR/TV.
- 3 Oprima el botón MENU para que aparezca la pantalla del MENU.
- 4 Use la RUEDA para elegir "CLOCK" y luego para elegir "AUTO SET".

- Si ud. esta usando una caja de TV por cable y tiene muchos canales PBS, sintonice la caja de TV por cable a un canal PBS diferente e intente la fijación automática otravez.

Caso 2 Si aparece la pantalla anterior, la fijación automática del reloj no es disponible en su zona. Por favor fije la hora del reloj manualmente como describe en la pagina siguiente.

- Para ver un canal anulado desde la memoria del aparato, por favor elija el canal con las teclas numéricas.
- Por cualquier razón, si ha cambiado la hora manualmente, no funcionará la corrección automática de la hora.
- La fijación automática del reloj efectuará cada día al apagar la combinación de VCR/TV por primera vez. Si ud. usa una caja de TV por cable y desea efectuar la fijación automática del reloj, la caja de TV por cable debe permanecer encendido y sintonizado el canal PBS cuando se apaga la combinación de VCR/TV.

Fijación manual del reloj

1 Oprimir MENU para que aparezca la pantalla de la fijación del reloj.

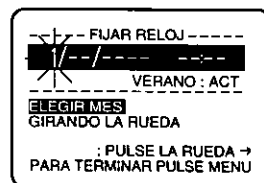

2 Girar y oprimir la RUEDA para elegir y fijar el mes, la fecha, el año, la hora y la hora veraniega.

Para hacer correcciones, oprimir la RUEDA o el botón CLEAR repetidamente para retroceder o avanzar hasta el paso que desea corregir.

3 Oprimir MENU dos veces para iniciar a funcionar el reloj y salir desde este modo.

Operaciones para ver la TV

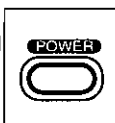
- 1  Oprimir POWER para encender la combinación de VCR/TV.

- 2 Elegir el canal usando CHANNEL UP/DOWN o usando la teclas numéricas.

- 3  Oprimir VOLUME UP/DOWN para ajustar el nivel del volumen.

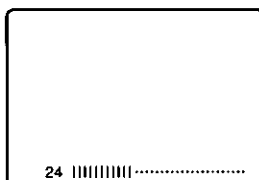

Fijación del encendedor automático

La combinación de VCR/TV se puede fijar para que se encienda automáticamente a una hora programada.

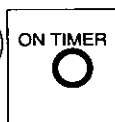
- 1  Oprimir ON TIMER para que aparezca la pantalla del encendedor automático.

- 2  Girar y oprimir la RUEDA para fijar la hora.

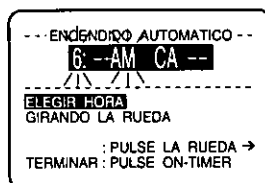

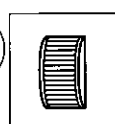
- 3  Para fijar el modo de TV o reproducción del encendedor automático, gire y oprima la RUEDA para elegir un canal para el modo de TV o para elegir "PLAY" para el modo de reproducción.

- Asegúrese de que una cinta de video esté introducido en la combinación de VCR/TV, si ha elegido la reproducción de la videograbadora.

Para hacer correcciones

Oprimir la RUEDA o el botón CLEAR repetidamente para retroceder o avanzar hasta el paso que desea corregir.

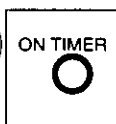
- 4  Oprimir el botón ON TIMER para fijar la función del encendedor automático. Esta pantalla aparecerá cerca de 5 segundos.

- El indicador de ON TIMER (encendedor automático) se encenderá en el panel delantero.

ENCENDIDO AUTOMATICO
FIJADO
ANULAR : PULSE CLEAR

Para cancelar, oprimir el botón CLEAR cuando está mostrado la pantalla anterior. "ENCENDIDO AUTOMATICO ANULADO" aparecerá en la pantalla cerca de 5 segundos.

- 60 minutos luego de que la combinación de VCR/TV se ha encendido automáticamente, éste se apagará por sí mismo si no se ha oprimido ningún botón del control remoto o del aparato.

Fijación del temporizador para dormir

La combinación de VCR/TV se puede fijar para que se apague automáticamente.

- 1 Oprimir SLEEP para que aparezca el tiempo de fijación.

TEMPORIZADOR PARA DOMIR 30
TEMPORIZADOR PARA DOMIR 60
TEMPORIZADOR PARA DOMIR 90
TEMPORIZADOR PARA DOMIR 00

- Si ud. oprime el botón DISPLAY con el temporizador para dormir fijado, aparecerá en la pantalla el tiempo que sobra para apagarse.

TEMPORIZADOR
PARA DORMIR 12

Para cancelar, oprimir SLEEP sucesivamente hasta que aparezca "TEMPORIZADOR PARA DORMIR 00".

Operaciones básicas para la grabación

- 1** Introducir una cinta de video que tenga la lengüeta para evitar el borrado.

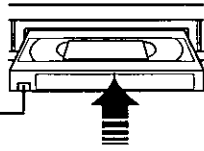

- La combinación de VCR/TV se enciende automáticamente.

- 2** Oprimir CH UP o CH DOWN para elegir el canal.

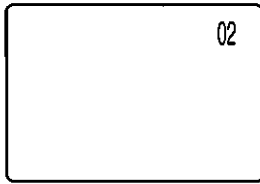
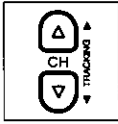

- Para grabar desde una fuente externa, oprimir CH UP/DOWN y elija LINEA.

- 3** Oprimir SPEED hasta que aparezca la velocidad deseada.

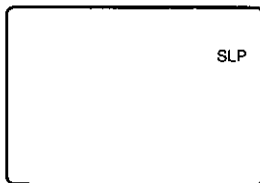
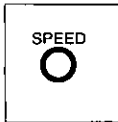

- SP = reproducción normal, LP = reproducción larga, SLP = reproducción super larga.

- 4** Oprimir el botón REC/TIME del control remoto para empezar a grabar.

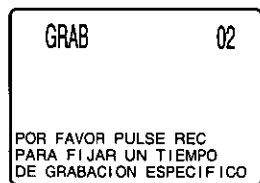
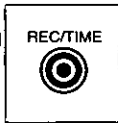

- U oprimir los botones PLAY y REC/TIME de la combinación de VCR/TV.

Luego de 2 segundos

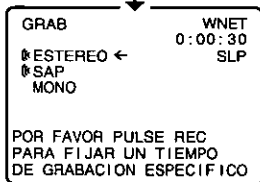

Grabación de un toque (OTR)

La combinación de VCR/TV se puede fijar para parar la grabación a una hora fijada anteriormente.

Oprima sucesivamente REC/TIME para fijar el tiempo de la grabación.

Cada presión cambiará la hora de parada como demuestra a la derecha.

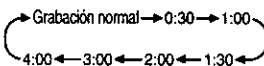

- La luz indicador de la grabación programada (TIMER) se enciende en el panel delantero.
- Oprimir el botón PAUSE para hacer una pausa en la grabación de un toque.

- 5** Oprimir STOP para parar la grabación.

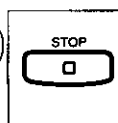

Grabación con temporizador

- 1** Oprimir PROG para que aparezca la pantalla para la programación.

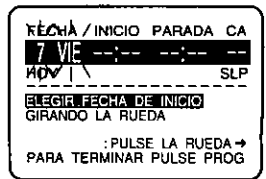
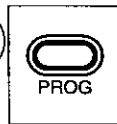

- Si ya existe una programación memorizada, elija con la rueda un número sin programación.

- 2** Girar y oprimir la RUEDA para elegir y fijar la fecha.

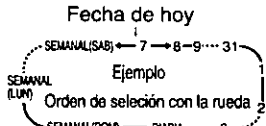
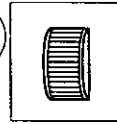

Grabación diaria y semanal

Si ud. desea programar una grabación diaria (lunes a viernes), elija DIARIO en vez de la fecha en el paso 2. Si desea una grabación semanal, elija SEMANAL LUN, MAR, etc.

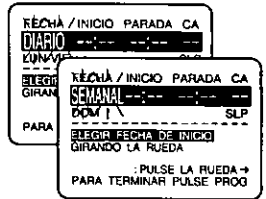

- 3** Girar y oprimir la RUEDA para elegir y fijar las fijaciones a la derecha.

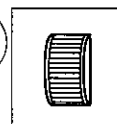

Fijaciones:

- Hora de inicio
- Hora de parada
- Canal o LINEA para una fuente externa
- Velocidad de la cinta (SP, LP, SLP)

Para hacer correcciones

Oprimir repetidamente la rueda para avanzar o el botón CLEAR para retroceder hasta el paso que desea corregir.

- 4** Oprimir PROG para terminar la programación.

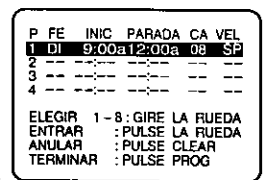
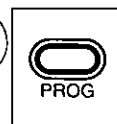

- Si desea hacer más programaciones, elija un número de programa en blanco con la rueda y repita los paso 2 y 3.

- 5** Oprimir PROG para salir desde este modo.

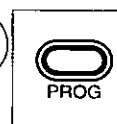

- La luz indicador de la grabación programada (TIMER) se enciende en el panel delantero.

Dos minutos antes de empezar la grabación, "GRABACION PROGRAMADA INICIARA ENSEGUIDA" aparecerá en la pantalla.

**Matsushita Consumer Electronics
Company, Division of Matsushita
Electric Corporation of America**
One Panasonic Way Secaucus,
New Jersey 07094

Printed in U.S.A.
VQTS3195(A)

**Panasonic Sales Company,
Division of Matsushita Electric of
Puerto Rico, Inc. ("PSC")**
Ave. 65 de Infanteria. Km. 9.5
San Gabriel Industrial Park, Carolina,
Puerto Rico 00985

